

.....
Date..... April 26, 2010

WHEREAS, on April 12, 2010 by Roll Call No. 10-506, it was duly resolved by the City Council that the City Council consider a proposal from Foods, Inc. to rezone certain property located in the vicinity of 3401 and 3407 Ingersoll Avenue, from the NPC District classification to the PUD Planned Unit Development District classification, and that such proposal be set down for hearing on April 26, 2010, at 5:00 P.M., in the Council Chambers at City Hall; and,

WHEREAS, due notice of said hearing was published in the Des Moines Register on April 15, 2010, as provided by law, setting forth the time and place for hearing on said proposed amendment to the Zoning Ordinance; and,

WHEREAS, the Legal Department has prepared an amended to the Zoning Ordinance of the City of Des Moines to rezone the property located in the vicinity of 3401 and 3407 Ingersoll Avenue, more fully described as follows (the "Property"):

Land zoned PUD by Ordinance Number 14,744 dated February 11, 2008:

Lots 9, 10 and 11 Crescent Place, an Official Plat; and Lots 16, 17, 18 & 19, Stratford, an Official Plat (Except a portion of Lot 19 beginning at the NW corner of said Lot 19, thence S89°20'55"E, 79.89 feet along the North line of said Lot 19 to a point, thence S89°27'48"W, 69.88 feet to a point; thence S45°24'33"W, 14.06 feet to a point on the West line of said Lot 19; thence N00°00'03"W, 20.04 feet along said West line to the Point of Beginning), all now included in and forming a part of the City of Des Moines, Polk County, Iowa.

Land to be rezoned from NPC to PUD and added to the above PUD (ordinance number 14744):

Lots 12 & 13, Crescent Place, an Official Plat; (Except a portion of Lot 12, beginning at the Southeast corner of said Lot 12: thence North 89 degrees, 18 minutes, 28 seconds West (all bearings referenced to Grid North Iowa State Plane Coordinate System South Zone) 5.42 feet along the South line of said Lot 12; thence North 11 degrees, 29 minutes, 32 seconds East, 27.72 feet to the East line of said Lot 12; thence South 00 degrees, 13 minute, 14 seconds West, 27.23 feet along said East line to the Point of Beginning), , AN OFFICIAL PLAT all now included in and forming a part of the City of Des Moines, IN POLK COUNTY, IOWA.

from the NPC District classification to the PUD Planned Unit Development District classification; and

.....
Date April 26, 2010

-2-

WHEREAS, the Plan and Zoning commission has recommended that the proposed rezoning and PUD conceptual plan be approved, subject to the conditions identified in the attached letter from the Planning Administrator; and

WHEREAS, in accordance with said notice those interested in said proposed rezoning, both for and against, have been given opportunity to be heard with respect thereto and have presented their views to the City Council.

NOW THEREFORE, BE IT RESOLVED, by the City Council of the City of Des Moines, Iowa, as follows:

1. Upon due consideration of the facts, statements of interested persons and arguments of counsel, the objections to the proposed rezoning and PUD Conceptual Plan are hereby overruled, and the hearing is closed.

2. The proposed rezoning and PUD conceptual Plan are hereby found to be in conformance with the Des Moines 2020 Community Character Land Use Plan, subject to the conditions identified below.

3. The PUD Conceptual Plan for the Property described above, which is on file in the Community Development Department, is hereby approved, subject to the plan being first amended to satisfy the following conditions, and subject to the Community Development Director finding that such conditions have been satisfied by the amendments to the plan:

1. Provision of bike racks near the entrance of the bank.
2. Provision of solid steel gate for any trash enclosure.
3. Restriction of the convenience store and carwash hours of operation from 6:00 A.M. to 11:00 P.M.
4. Use of 60-degree parking stalls where angled parking is designated.
5. Provision of a note that states parking shall be provided for all employees on site.
6. Parapet walls shall have a finished appearance on all sides as approved by the Community Development Director.
7. Provision of functional windows on the south façade of the convenience store to the satisfaction of the Community Development Director.
8. Prohibition of signage on the north façade of the carwash building.
9. Provision of ornamental fencing around the perimeter of the convenience store site along Ingersoll Avenue and 34th Street.

(Continued on Page 3)

Date..... April 26, 2010

10. Realignment of the carwash exit toward the convenience store (south).
11. Submission of written certification from the owner's lighting consultant that all site lighting is installed in accordance with the approved lighting plan and does not exceed 1 foot candle at the property lines prior to issuance of a Certificate of Zoning Compliance.
12. The access from the site to 34th needs to be two-way.
13. The City Traffic Engineer should consider no parking along Ingersoll in front of the apartment building.
14. There should be a "NO TRUCK" sign on Woodland Avenue.
15. There should be a curb cut break on the Ingersoll entrance drive for immediate access to the gas pumps.
16. The architecture of the bank should be differentiated from the look of the convenience store.

MOVED by _____ to adopt and approve the rezoning, subject to final passage of the rezoning ordinance.

FORM APPROVED:

 Michael F. Kelley
 Assistant City Attorney

COUNCIL ACTION	YEAS	NAYS	PASS	ABSENT
COWNIE				
COLEMAN				
GRIESS				
HENSLEY				
MAHAFFEY				
MEYER				
MOORE				
TOTAL				
MOTION CARRIED			APPROVED	
_____ Mayor				

CERTIFICATE

I, DIANE RAUH, City Clerk of said City hereby certify that at a meeting of the City Council of said City of Des Moines, held on the above date, among other proceedings the above was adopted.

IN WITNESS WHEREOF, I have hereunto set my hand and affixed my seal the day and year first above written.

_____ City Clerk

Date 4-26-10

Agenda Item 59

Roll Call # _____

April 5, 2010

Honorable Mayor and City Council
City of Des Moines, Iowa

Members:

Communication from the City Plan and Zoning Commission advising that at their meeting held April 1, 2010, the following action was taken:

COMMISSION RECOMMENDATION:

After public hearing, the members voted 10-0-1 as follows:



CITY PLAN AND ZONING COMMISSION
ARMORY BUILDING
602 ROBERT D. RAY DRIVE
DES MOINES, IOWA 50309 - 1881
(515) 283-4182

ALL-AMERICA CITY
1949, 1976, 1981
2003

Commission Action:	Yes	Nays	Pass	Absent
Leisha Barcus	X			
JoAnne Corigliano	X			
Shirley Daniels	X			
Jacqueline Easley				X
Dann Flaherty				X
Joel Huston	X			
Ted Irvine	X			
Jeffrey Johannsen	X			
Greg Jones	X			
Jim Martin				X
Brian Millard			X	
William Page	X			
Mike Simonson	X			
Kent Sovern	X			

APPROVAL of a request from Foods, Inc. (owner) to find the requested rezoning in conformance with the Des Moines' 2020 Community Character Plan.

By separate motion Commissioners recommended 6-4-1 as follows:

Commission Action:	Yes	Nays	Pass	Absent
Leisha Barcus		X		
JoAnne Corigliano	X			
Shirley Daniels	X			
Jacqueline Easley				X
Dann Flaherty				X
Joel Huston	X			
Ted Irvine	X			
Jeffrey Johannsen	X			
Greg Jones		X		
Jim Martin				X
Brian Millard			X	
William Page		X		

Commission Action:	Yes	Nays	Pass	Absent
Mike Simonson		X		
Kent Sovern	X			

APPROVAL to amend the Dahl's Foods Ingersoll Avenue PUD Conceptual Plan to incorporate the property at 3401 and 3407 Ingersoll Avenue to allow the construction of a 5,300-square foot building, 6 fuel pumps (12 fueling stations) and an automatic carwash and to rezone from "NPC" Neighborhood Pedestrian Commercial District to "PUD" Planned Unit Development subject to the following conditions: ZON2009-00012.

1. Provision of bike racks near the entrance of the bank.
2. Provision of solid steel gate for any trash enclosure.
3. Restriction of the convenience store and carwash hours of operation from 6:00 A.M. to 11:00 P.M.
4. Use of 60-degree parking stalls where angled parking is designated.
5. Provision of a note that states parking shall be provided for all employees on site.
6. Parapet walls shall have a finished appearance on all sides as approved by the Community Development Director.
7. Provision of functional windows on the south façade of the convenience store to the satisfaction of the Community Development Director.
8. Prohibition of signage on the north façade of the carwash building.
9. Provision of ornamental fencing around the perimeter of the convenience store site along Ingersoll Avenue and 34th Street.
10. ~~Provision of signage and painted pavement markings identifying the 34th Street drive as "entrance only."~~
11. Realignment of the carwash exit toward the convenience store (south).
12. Submission of written certification from the owner's lighting consultant that all site lighting is installed in accordance with the approved lighting plan and does not exceed 1 foot candle at the property lines prior to issuance of a Certificate of Zoning Compliance.
13. The access from the site to 34th needs to be two-way
14. The City Traffic Engineer should consider no parking along Ingersoll in front of the apartment building
15. There should be a "NO TRUCK" sign on Woodland Avenue
16. There should be a curb cut break on the Ingersoll entrance drive for immediate access to the gas pumps.
17. The architecture of the bank differentiated from the look of the convenience store.

Written Responses

5 In Favor

14 In Opposition

STAFF REPORT

1. **Purpose of Request:** The applicant wishes to add the property at 3401-3407 Ingersoll Avenue to their adjoining grocery store site. This site contains a bank building, which would be torn down and replaced by a convenience store with 12 fueling stations and a stand-alone automatic carwash. A new bank building would be constructed in the southwest corner of the Dahl's property at the 35th Street and Ingersoll Avenue intersection. The existing PUD Concept Plan for the Dahl's site includes a building at

the 35th Street and Ingersoll Avenue intersection that would contain a convenience store with 10 fueling stations and a coffee shop.

The proposed amendment also identifies the location of a temporary 12-foot by 40-foot trailer that would house the bank while their building was being constructed. The plan includes a note that states that the trailer will be in operation during the construction of the bank and would be removed upon the re-opening of the bank in the new building.

2. **Size of Site:** 260,489 square feet or 5.98 acres.
3. **Existing Zoning (site):** "PUD" Planned Unit Development District and "NPC" Neighborhood Pedestrian Commercial District.
4. **Existing Land Use (site):** Grocery store and bank.
5. **Adjacent Land Use and Zoning:**
 - North* – "R-4" & "R1-60"; Uses are multiple-family and single-family residential.
 - South* – "NPC"; Use is a bank and multiple-family residential.
 - East* – "NPC" & "R1-60"; Uses are multiple-family and single-family residential.
 - West* – "NPC", "C-0" & "R1-60"; Uses are Walgreen's Pharmacy, a beauty salon, and single-family and two-family dwellings.
6. **General Neighborhood/Area Land Uses:** The subject site encompasses the city block bound by Ingersoll Avenue to the south, 35th Street to the west, Woodland Avenue to the north and 34th Street to the east. The surrounding area generally consists of single-family dwellings to the north, west and east with multiple-family residential, commercial and institutional uses along the Ingersoll Avenue and Grand Avenue corridors.
7. **Applicable Recognized Neighborhood(s):** North of Grand Neighborhood.
8. **Relevant Zoning History:** On February 11, 2008, the City Council approved Ordinance Number 14,744 rezoning the existing Dahl's site (3425 Ingersoll Avenue) from "NPC" to "PUD" and approved the Dahl's Foods "PUD" Concept Plan.
9. **2020 Community Character Land Use Plan Designation:** Commercial: Pedestrian-Oriented Corridor.

The 2020 Community Character Plan states the following regarding this land use designation.

Commercial Pedestrian Oriented: Site orientation is balanced between the needs of the pedestrian and the convenience of the motorist. The development is compact and walkable connections to adjacent areas exist via public streets and sidewalks.

Commercial Corridor: Small-to-moderate scale commercial serving adjacent neighborhoods and specialty retail and services needs. Generally consisting of a cumulative building total of 75,000 to 100,000 square feet.

10. Applicable Regulations: The Commission reviews all proposals to amend zoning regulations or zoning district boundaries within the City of Des Moines. Such amendments must be in conformance with the comprehensive plan for the City and designed to meet the criteria in §414.3 of the Iowa Code. The Commission may recommend that certain conditions be applied to the subject property if the property owner agrees in writing, in addition to the existing regulations. The recommendation of the Commission will be forwarded to the City Council.

II. ADDITIONAL APPLICABLE INFORMATION

1. PUD Standards: The following are standards from Section 134-704 of the City Code that provide the foundation that all PUD Concept Plans should be based on.

A) All uses proposed in a PUD planned unit development district plan shall be in harmony with the existing or anticipated uses of other properties in the surrounding neighborhood and shall generally be in conformance with the city's land use plan. The design of a PUD development shall be based on harmonious architectural character; compatible materials; orderly arrangement of structures and open space; and conservation of woodlands, streams, scenic areas, open space and other natural resources.

Staff believes that the proposed bank and convenience store match the development pattern in the Ingersoll Avenue area. The submitted amendment includes the previously approved note that restricts any replacement uses to those allowed in the "C-1" District. The "C-1" District does not allow for some of the more intense uses that both the "C-2" and "NPC" Districts allow. This protects the surrounding residential neighborhood to the north from the more intense uses given the depth of the site. In addition, staff believes that the hours of operation for the convenience store and carwash should be limited to 6:00 A.M. to 11:00 P.M. to limit the impact on the surrounding residential area.

The architectural character and site design are discussed in Section II, subparagraph 2 and 3 of this report.

B) Setbacks and other appropriate screens shall be provided around the boundary of a PUD development to protect the adjoining district properties. Only in exceptional circumstances shall such a setback be less than the amount of the setback which the adjoining district is required to maintain from the PUD development.

The proposed convenience store and bank buildings would have zero foot setbacks from Ingersoll Avenue, which is in keeping with the "NPC" District design guidelines. The fuel pumps and canopy would be located 57 feet north of the convenience store and 55 feet west of the 34th Street right-of-way. The carwash would be located 145 feet north of the convenience store and 90 feet west of the 34th Street right-of-way. The Concept Plan includes a significant amount of landscaping to screen the convenience store and carwash from the single-family residences to the northwest. The plan also includes a note stating that the property owner shall work with the neighborhood association and staff regarding landscape and lighting design along 34th Street and Ingersoll Avenue prior to the approval of the Final Development Plan.

- C) *A PUD development shall comply with all applicable city ordinances, specifications and standards relating to all dedicated street, sanitary sewer and storm sewer facilities and to surface drainage and floodwater retention.*

No additional streets are necessary as part of this development. The submitted concept plan indicates that storm water will be handled by an underground storm water detention system.

- D) *The streets surrounding a PUD development must be capable of accommodating the increased traffic that would be generated by the new development. The development shall be designed to provide maximum feasible separation of vehicular traffic from pedestrian ways and recreational areas. If turning lanes or other forms of traffic controls within or adjacent to the development are deemed necessary by the city council, the developer shall provide the necessary improvements.*

Please refer to the attached report from the City Traffic Engineer.

- E) *Off-street parking and loading spaces shall be provided as appropriate to the size and character of the development. Each off-street loading space shall be not less than ten feet in width and 25 feet in length. All off-street parking spaces shall be provided in accordance with the requirements of subsection 134-1377(g).*

The existing Concept Plan includes a total of 231 off-street parking stalls for the grocery store and the 5,600-square foot convenience store and coffee shop building. The submitted plan amendment includes 186 off-street parking spaces. Sixteen (16) are generally associated with the convenience store. The spaces for the grocery store and bank intermingle with no clear division. There are 5 on-street stalls on Ingersoll Avenue in front of the convenience store. This is 45 less stalls than the existing PUD Concept Plan. The proposed amendment also includes the reorientation of the north portion of the parking lot from 90-degree stalls to 45-degree stalls to address frequent complaints Dahl's has received regarding the 90-degree stalls. The applicant's engineer has indicated that this change reduces the number of stalls in the northern portion of the lot by 27. If the angled stalls were converted to 60-degree stalls then the number of stalls in the northern portion of the lot would be reduced by only 13 stalls.

The City's parking standards for "C" Districts would require 329 spaces for the 67,854-square foot grocery store, 13 spaces for the 3,935-square foot convenience store and 5 spaces for the 1,573 square feet bank for a total of 347 spaces. Most of the Ingersoll Avenue corridor is zoned "NPC" District, which allows for a 40% reduction in the amount of required off-street parking. The "NPC" District parking standards would require a minimum 208 stalls and would allow the 5 on-street stalls in front of the convenience store to count towards meeting this requirement. The proposed 186 off-street parking stalls represent 54% of the "C" District standard. If the angled stalls were converted to 60-degree stalls then the site would have a total of 201 spaces, which would represent 58% of the "C" District standard.

The applicant has been operating the grocery store with only the northern half of the parking lot developed. Staff expects that most of the bank's business will be handled though the drive-thru lanes and the number of off-street parking spaces that adjoin the convenience store (16 stalls) exceed the number that would be

required in a "C" District (13 stalls). Staff believes that if 60-degree stalls are used in place of 45-degree stalls that the proposed amount of parking is sufficient to adequately support the development without forcing customers or employees to park on nearby residential streets.

- F) *Where appropriate to the size and character of a PUD development, provision shall be made therein for open space for recreation and other outdoor uses, and for places of worship, convenience shopping and other community services.*

The PUD will provide convenient commercial services for the surrounding area.

2. **Urban Design:** Most of the Ingersoll Avenue corridor is zoned "NPC" Neighborhood Pedestrian Commercial District. This district includes specific design guidelines to ensure that new development blends with the area's existing character. Staff believes elements from the NPC District should be incorporated into the proposed development. The following are the NPC District Design guidelines from the City Code and a discussion of the proposed development's architectural and site design elements.

Section 82-214. Design Guidelines within NPC Districts

- A) Buildings should frame the street and maintain a minimal setback from the street.
- B) Building frontage should occupy at least 50% of the primary street frontage.
- C) The front entrance should be oriented to the street. On a corner lot, the building should have a well-defined entrance on the primary commercial street.
- D) The front facade of the first floor of the building on the primary commercial street should have a ratio of at least 40 percent window and window display area to total street facade.
- E) Materials should be brick, stone, tile, stucco, or horizontal wood clapboard with a maximum width of six inches. Two-story buildings are encouraged.
- F) Commercial buildings with over 50 feet of building frontage should have the appearance of being broken into separate bays of between 20 to 35 lineal feet using structural elements, fenestration patterns, protruding or recessed bays, or architectural details.
- G) The following bulk regulations should be observed:
 - 1. Minimum Lot Area for a multiple dwelling structure: Minimum of 10,000 square feet and 2,000 square feet per dwelling unit.
 - 2. Front yard: minimum of zero feet.
 - 3. Side yards: minimum of zero feet.
 - 4. Rear yard: None required, except when adjoining any R or C-0 district or portion of a PUD designated for residential use, in which case ten feet.
 - 5. Height: minimum of 15 feet, maximum of 45 feet.
 - 6. Number of stories:
 - Residential uses, a maximum of four stories.
 - All other permitted uses, a maximum of two stories.
- H) Signs, which are attached or projecting from the building and designed for the character of the building, are preferred. Monument signs are allowed.

The proposed convenience store and bank buildings would be constructed along Ingersoll Avenue and would have direct entrances from the Ingersoll Avenue sidewalk. Staff believes that the fencing that is to be installed along the grocery store and bank parking lot should be installed around the convenience store portion of the site for continuity. The fencing helps create an edge along the streets, which in conjunction with the convenience store and bank buildings, give the site a street presence.

The proposed convenience store, carwash and bank buildings would be constructed with a mix of red brick, cultured stone and EIFS with details to match the existing grocery store building. The submitted elevations indicate that the bank windows would have tinted glazing, that the carwash windows on the south façade would be spandrel glazing, and that the convenience store would have tinted windows on the north façade and predominately glass block on the south façade. Only the door and a small tinted window to the west of the door would allow visibility into the store. The glass block would be faux windows as the applicant wishes to use most of the south wall for coolers and/or backroom activities. The applicant has offered a second alternative of replacing the tinted glass with clear glass and the glass block with tinted glass.

The south facade must fit the character typical of the Ingersoll Avenue corridor and meet the intent of the "NPC" District design standards. The "NPC" design standards require that 40% of the 1st floor of the front façade be made up of windows. The proposed glass block and glazing represents approximately 45% of the Ingersoll façade. However, the faux windows whether glass block or tinted glazing will not engage the street. This does not meet the intent of the window requirement. Staff believes that the internal layout of the building could be altered to allow more windows. Staff believes that the central and western bay of windows should be functional windows. Staff would support the eastern bay being converted to all brick as generally illustrated on the north façade. This would reduce the amount of windows on the Ingersoll façade to approximately 30%. Moving the door to and enlarging the central bay and converting the east and west bays to clear story windows or brick might also be acceptable compromises.

The convenience store would have a wall sign on all four facades. The building elevations include landscaping that obscures the view of the signs on the east and west façade. Staff has requested the applicant to provide graphics illustrating the signs. Signs in these locations should be appropriate if they are generally of the same character as the other signs. The bank would have a wall sign on each façade. The carwash building would have a wall sign on the south and north facades and a smaller sign on the east and west facades. Staff believes that the proposed signage is appropriate if the sign on the north façade of the carwash is eliminated.

- 3. Site Improvements & Landscaping:** The proposed amended Concept Plan shows an 8-foot wide scored sidewalk along Ingersoll Avenue and a 4-foot wide sidewalk along 34th Street. The plan shows that the Ingersoll Avenue streetscape improvements would be extended east along the convenience store to 34th Street. In general, the landscaping shown on the proposed amendment is consistent with the style and quality of the currently approved PUD Concept Plan.

The submitted amendment includes a driveway to 34th Street that would be enter-only to limit the number of vehicles using 34th Street. The applicant has indicated that the primary need for this driveway is to allow fuel trucks access to the site. Staff believes that both signage and painted pavement markings are needed to adequately communicate that this driveway is an entrance only. The site currently has a two-way driveway to 34th Street in addition to the loading dock driveway in accordance with the approved PUD Concept Plan.

The applicant's first submittal showed the carwash sitting further to the east with its entrance to the west and its exit to the east near the 34th Street driveway. The

applicant has shifted the carwash to the west to provide greater separation from the residences to the east and north. The entrance to the carwash has been reoriented to the east so vehicles exit away from 34th Street to lessen the likelihood they will exit the site onto 34th Street. To accomplish this, the carwash exit needs to be designated as right-turn only, so a conflict is not created with the one-way traffic heading towards the store from the Ingersoll Avenue driveway. This forces all of the vehicles exiting the carwash to drive past the front door of the grocery store. Staff believes that the carwash could be shifted slightly to the east to allow vehicle to exit towards the convenience store and ultimately exiting the site to Ingersoll Avenue or 35th Street if they do not need to park. This would improve the pedestrian and vehicle circulation within the site while still reducing the impacts of the carwash.

The submitted PUD Amendment contains all of the notes from the current Concept Plan including the note that exterior lighting levels shall not exceed 1 foot candle at all property lines. Light spillage on the neighborhood to the north and east has been a problem as the existing lighting was not installed at the proper angles. Dahl's recently adjusted the lights to correct this issue. To avoid this issue in the future staff recommends that the owner's lighting consultant be required to submit written verification that the lights comply with the 1 foot candle requirement immediately after installation.

The existing PUD Concept Plan was approved prior to the adoption of the City's Gas Station/Convenience Store Design Guidelines. Staff has reviewed the new proposal and found that it complies with all but the following design standards.

- *Minimum open space should be 20% of the site or 1,000 square feet per vehicle fueling location, whichever is greater.*
- *Auto repair bay openings and car-wash openings should be oriented away from residential uses.*
- *Direct light trespass beyond property lines is prohibited. The maximum horizontal illuminance at grade and the maximum vertical illuminance at five feet above grade measured at the property line should not exceed Illuminating Engineering Society of North America (IESNA) recommended practices for light trespass. (0.5 footcandles for residential, 2.0 footcandles for commercial). The site plan must contain illuminance models showing light levels throughout the site.*

Staff believes that not complying with these guidelines is acceptable in this instance given the urban character of the Ingersoll corridor, the limited amount of space available on the site and the fact that a significant portion of the development is already constructed based on the standards from the approved PUD Concept Plan.

STAFF RECOMMENDATION TO THE P&Z COMMISSION

Part A) Staff recommends that the Commission find the requested rezoning in conformance with the Des Moines' 2020 Community Character Plan.

Part B & C) Staff recommends approval of the proposed rezoning and PUD Concept Plan amendment subject to the following conditions:

1. Provision of bike racks near the entrance of the bank.

2. Provision of solid steel gate for any trash enclosure.
3. Restriction of the convenience store and carwash hours of operation from 6:00 A.M. to 11:00 P.M.
4. Use of 60-degree parking stalls where angled parking is designated.
5. Provision of a note that states parking shall be provided for all employees on site.
6. Parapet walls shall have a finished appearance on all sides as approved by the Community Development Director.
7. Provision of functional windows on the south façade of the convenience store to the satisfaction of the Community Development Director.
8. Prohibition of signage on the north façade of the carwash building.
9. Provision of ornamental fencing around the perimeter of the convenience store site along Ingersoll Avenue and 34th Street.
10. Provision of signage and painted pavement markings identifying the 34th Street drive as "entrance only."
11. Realignment of the carwash exit toward the convenience store (south).
12. Submission of written certification from the owner's lighting consultant that all site lighting is installed in accordance with the approved lighting plan and does not exceed 1 foot candle at the property lines prior to issuance of a Certificate of Zoning Compliance.

SUMMARY OF DISCUSSION

Brian Millard declared a conflict and did not participate with this part of the meeting.

Jason Van Essen presented staff report and recommendation.

Mike Simonson asked staff to review the difference between the parking spaces as approved by P&Z and Council versus the new plan at this time and how existing lighting might have been adjusted.

Jason Van Essen stated the existing Concept Plan includes a total of 231 off-street parking stalls for the grocery store, the convenience store and retail space. The submitted plan amendment includes 186 off-street parking spaces. This is 45 fewer stalls than on the existing PUD Concept Plan. If the angled stalls were converted to 60-degree stalls then the site would have a total of 206 parking spaces including 5 (five) on-street spaces: 206 spaces is 58% of the "C" District standard.

Mike Simonson asked what is required of the entire site if it was zoned "NPC" District.

Jason Van Essen stated if the entire site was zoned "NPC" District, then 208 stalls would be required, including 5 on-street stalls in front of the convenience store.

Mike Simonson asked staff by way of reference, how many stalls did the old Dahl's have.

Jason Van Essen suggested that the applicant can respond to that question. However, the applicant has adjusted building and pole mounted lighting to address neighborhood concerns. The letter from Tesdell Electric confirmed that lighting levels were measured around the perimeter of the site and all readings are less than the 1 foot candle allowed at the property line.

Ted Irvine asked if the request is not granted would the angle parking be implemented on the existing PUD causing them to lose parking spaces.

Jason Van Essen stated that the Concept Plan spells out specifically how many stalls must be provided. Therefore, they would need to come back to the Plan and Zoning Commission to amend the Concept Plan because it will impact the spaces provided.

Dann Flaherty left the meeting @ 6:30.

Larry James Jr. 699 Walnut representing Foods Inc. Since the last time he was before the Commission, Dahl's has been offered the opportunity to purchase the Meta Bank site. Because Dahl's has been receiving frequent complaints regarding the 90-degree stalls, they wanted to take a look at angled stalls. If the angled stalls were converted to 60-degree stalls then the number of stalls would be 201 plus 5 on-street stalls. The convenience store would be the only store in Des Moines that is located with the building immediately adjoining the street. Dahl's has received letters of support from North of Grand Neighborhood Association with conditions, Linden Heights, Salisbury Oaks, Ingersoll Area Business Association, Hopkins and Huebner, and Westside Chamber of Commerce.

Kent Sovern asked if the applicant had any comments on the staff recommendations.

Larry James Jr. stated that they agree with staff recommendations 1 through 12. They are still working on recommendations 6 and 7. The lighting meets zoning requirements but Dahl's is still working with residents to go above and beyond code. The carwash has no signage on the north elevation per the staff recommendation.

Leisha Barcus asked about the lighting of the c-store and whether the neighborhood associations support the c-store. She also asked if the support is for the carwash or where the carwash is located.

Larry James Jr. stated that Dahl's has tried to address the concerns of the neighbors. The design of the canopy and site lighting is in the spirit of the convenience store guidelines that the City recently enacted. Dahl's wants to work towards the 1 foot candle requirement of the new plan.

Leisha Barcus asked what effect the c-store would have on neighborhoods that don't directly adjoin the site.

Larry James Jr. stated he will let the individual neighborhoods answer that question.

Leisha Barcus asked if circulation on the lot would work better with the convenience store on 35th Street.

Larry James Jr. stated that the convenience store on 35th Street does not work with diagonal parking as shown. Also Dahl's did not want the bank at 35th Street either but tried to address the neighbors' concerns.

Greg Jones asked how many cars would be parked on the site during peak time for grocery sales such as Christmas.

Larry James Jr. stated the difficulty in this whole process is trying to balance these issues. Dahl's is confident that the number of spaces provided will address those concerns.

Brett Johnson CEC 2400 86th Street stated that Dahl's is redeveloping the entire block now. The actual square footage of building space is 3,000 square feet less than previously approved. Therefore, fewer parking spaces are needed.

CHAIRPERSON OPENED THE PUBLIC HEARING

The following spoke in favor:

Stephanie Jewell representing the Ingersoll Business Association, 1922 Ingersoll Avenue stated they support Dahl's plan. The Association feels that the proposed plan is the best interest of the Ingersoll community and will only add value to this area and thinks that this plan will generate additional interest in the continuation of the Ingersoll restoration project.

Leisha Barcus asked why Ms. Jewell liked the current proposal over the previous proposal.

Stephanie Jewell stated she did not see the previous proposal, but heard about it. They are excited about the gas station, the c-store and the landscaping.

Leisha Barcus asked if the things Ms. Jewell liked about the new plan were that it contained a convenience store, gas station and Ingersoll restoration landscaping, would she also like the existing plan?

Stephanie Jewell stated yes, but they would also want to be sure the neighbors and Dahl's are happy too.

Fred Van Liew president of Linden Heights Neighborhood Association 4245 Foster Drive stated that they unanimously support Dahl's request and believes the new development will serve as a retail anchor. This proposal will improve the look and feel along Ingersoll Avenue, will create jobs, and add to the tax base. It is also in line with the Ingersoll Restoration Project.

Will Page asked for confirmation of the Linden Heights Neighborhood Association boundaries.

Fred Van Liew stated the Linden Heights Neighborhood is bounded on the north by Grand Avenue, south by Foster Drive, east by 42nd Street, and west by Greenwood Park.

Leisha Barcus asked if Linden Heights Neighborhood Association was aware of the previous plan, and what they thought of it.

Fred Van Liew stated the Linden Heights Neighborhood Association was aware of the previous plan and was happy to hear that Dahl's was able to purchase the Meta Bank site because it allows more comprehensive development.

John Schissel 3803 Brentwood Drive, Salisbury Oak Neighborhood Association stated that they have been made aware of the existing and new plans and thinks the new plan is better, more consistent and concise and the sooner it is completed the better.

The following were in opposition:

Kimberly Hansen 4015 Woodland Avenue, North of Grand Neighborhood Association requested that the Commission read, receive and file the neighborhood letter. She did not realize that other neighborhood associations could voice their opinion in what happens to the resident's homes in North of Grand neighborhood. The North of Grand Neighborhood Association's concerns are the operational hours of the convenience store which are 6:00 a.m. to 11:00 p.m. in a spot where the bank's operational hours are from 9:00 a.m. to 5:00 p.m. next to residential instead of locating at 35th Street commercial corner. They are also concerned with the increase in traffic, and how this proposal will affect the quality of life in the neighborhood on 34th and Woodland Avenue. The lighting was corrected last week, which was good. They are in support of the plan but are concerned about locating the c-store at 34th Street. Photos were shown of a semi on 34th Street driving from Woodland and expect that will be worse with a convenience store at 34th Street.

Leisha Barcus asked if the North of Grand Neighborhood Association was in support of the previous plan.

Kimberly Hansen stated the North of Grand Neighborhood Association supports the 2008 PUD Plan. It took them about two years to work on it. They support the convenience store as long as it is located at 35th Street.

Will Page asked about the proposed location of the car wash.

Kimberly Hansen stated they did not understand the business model of the car wash and why it was a "make or break" deal on one side of the lot versus another.

Shirley Daniels confirmed that the North of Grand Neighborhood stated in their letter that they are favor of the carwash.

Ted Irvine stated that he is surprised about North of Grand Neighborhood Association's position regarding other neighborhood association's opinions and asked if City code or process prohibits other neighborhoods from participating.

Kimberly Hansen stated it is a public hearing. It just would have been nice if the other neighborhoods would have contacted the North of Grand Association to find out if they had valid concerns.

Ted Irvine asked about the offer by Dahl's to purchase the right of way on 34th Street and close the street making it a cul-de-sac and doing some landscaping to eliminate the trucks from going through.

Kimberly Hansen stated that the subcommittee of neighbors that live in that area felt it would affect their lives by increasing the emergency response time, and eliminating their ability to get on and off of Ingersoll at 34th Street.

Matt Cohen 711 41st Street member of North of Grand Neighborhood Association stated that he supports all of the individual components of the project but has concerns about the organization of uses. Dahl's is center of our neighborhood. It is a 5 to 10 minute walk radius and our goals are to maintain the pedestrian friendly environment, maximize the sensitivity of this development to the adjacent residential property and complimentary to the existing character of the neighborhood. The existing 2008 PUD made more sense as the more auto oriented use was located at 35th and Ingersoll.

Barry Molloy 627 39th Street stated he has been shopping at Dahl's 45 years. At the original meeting the goal was to separate truck and commercial traffic. There is a significant reduction of traffic on 35th Street making plenty of capacity for a convenience store. The convenience store would be directly across from residential uses on 34th Street versus being directly across from Walgreens on 35th Street.

Mark Siegfried 4105 Woodland stated he has been a Dahl's customer for 35 years. He is simply trying to minimize the impact on surrounding residential uses. Believes the 2008 PUD is better than the new plan. With the new plan there is less NPC character, the screening promised is gone, the retail space promised is gone, the outdoor seating promised is gone and forces it all of the traffic through the parking lot and out to the street light.

Colleen Kinney 632 40th Street member of North of Grand Neighborhood Association stated the safety is compromised by the new plan and she supports previous PUD. It is difficult for her to navigate safely through the pedestrian promenade which competes with the carwash, convenience store, and grocery store traffic.

Trudi O'Connell 637 34th Street stated that she is a 14 year resident and business owner at 3111 Ingersoll so she lives, works, and shops and has everything she needs within walking distance. She is concerned with the high volume of traffic, the impact on her quality of life, the noise, gas fumes, and increased traffic with the new plan. She supports the 2008 PUD plan and does not support the new plan.

Ted Irvine asked if she would support the cul-de-sac concept.

Trudi O'Connell stated not at this time.

Trina Braafhart 3317 Woodland stated her house is located 15 feet from the street. She would see the convenience store when looking south. The new location of the gas station would increase traffic in a negative way and she would like to see Dahl's stick with their original plan.

Ted Irvine asked if she would support the cul-de-sac concept.

Trina Braafhart 3317 Woodland stated that she did not think that it was ideal, but if it came to that she would entertain anything to reduce the traffic.

Susan Houts 3325 Crescent Drive directed the Commission to page 74 of the 2020 Community Character plan, where it states "new commercial should have access from commercial corridor and not residential side street, and primary consideration should be given to residents". Whereas, 34th Street used to be quiet, at 5:10 a.m. there is the noise and fumes from the parking lot sweeper with the light and dust coming through her windows. Visual, light, and fumes invades her privacy. Dahl's current proposal invades her privacy and she thinks the convenience store and fuel pumps should be on 35th Street.

Jeffrey Johannsen asked if she was opposed to the carwash

Susan Houts stated she was not but prefer it not be next to her house.

Ted Irvine asked if she would support the cul-de-sac concept.

Susan Houts stated that she did not see it as a compromise, but a last resort.

Jennifer Barsetti 3311 Woodland Avenue stated she does not support the new plan but she does support the old plan. Her concerns are the increased traffic, lighting, and noise on 34th Street.

Aaron Surber 633 34th Street stated that he is concerned about the safety of the intersection of 34th Street and Ingersoll. The parking in this new plan will reduce their quality of life. He prefers the 2008 PUD plan.

Ted Irvine asked if he would support the cul-de-sac concept.

Aaron Surber stated that he was hesitant.

Jackie Surber 633 34th Street stated that her concerns are the increase in traffic and decrease in safety. She is not in favor of the new proposal but prefers the 2008 PUD plan. She does not think she should have to consider the cul-de-sac on 34th Street to accommodate Dahl's.

Jim Stavneak 637 41st Street stated that it is logical for the proposal to go in at 35th Street not 34th Street. The convenience store is going to be open 17 hours a day. He supports the old PUD that locates the convenience store on 35th Street.

Rebuttal

Larry James Jr. stated that on 34th Street north of Crescent is residential and the bank is currently zoned "NPC" which allows a c-store with 8 fuel pumps as a permitted use. Dahl's is not requesting a change in the 2020 plan tonight as the plan before the Commission complies with the 2020 comprehensive plan. The cul-de-sac has been offered as a solution to the increase in traffic. A number of people who says they support the original PUD opposed it previously. He has given his personal cell number to answer questions. The semi in the picture shown on 34th Street is the exception to the rule Dahl's does not condone such action and has done everything in their power to address the resident's issues.

Jeffrey Johannsen asked if Dahl's were to change the parking to 45 degree angle would that negatively impact Dahl's.

Larry James Jr. stated that it lessens the number of spaces to be provided from 206 to 190.

JoAnne Corigliano asked if a "NO DAHLS ENTRANCE" sign could be posted on Woodland Avenue.

Larry James Jr. stated that they have approached the City for a "No truck traffic" sign on 34th Street. He also pointed out that Mapquest directs traffic onto Woodland from 31st Street.

Ted Irvine asked if Dahl's will buy Meta Bank if everything moves over to 35th Street and if not will Dahl's landscape the entire 3400 block of Ingersoll in consistent with the restoration plan.

Larry James Jr. stated they would not purchase Meta Bank and they would not landscape in front of the bank if the c-store is located at 35th Street.

CHAIRPERSON CLOSED THE PUBLIC HEARING

Mike Simonson stated the existing plan was compromised, he supports the c-store on the site, thinks removing the Meta Bank building is a good decision and adding a new bank facility is good. Not crazy about the carwash. Dahl's is telling us that not having the carwash is a deal breaker. He finds it hard to believe that the income from a carwash will make or break a project but will accept the statement at face-value. However, he does not accept the location of the convenience store building on 34th Street. All of the traffic exiting the c-store will occur at the lynch pin of this entire site plan. He proposed keeping the carwash where it is and locating the c-store and the bank on 35th Street which will pick up 20 additional parking spaces and have the same amount of green space.

Greg Jones stated that the Commission worked hard the first time on their recommendation to the City Council, and even proposed a smaller store. Had Dahl's constructed a smaller store they may have made more room for parking. His concerns are the reduction in parking spaces, and believes the original plan was more consistent with the "NPC" District.

Shirley Daniels stated this has been a long process and feels that Dahl's has made good efforts to address everyone's concerns. Deliveries are not just Dahl's problem, it happens in other places as well. The cul-de-sac might be a good solution to the truck traffic on 34th and Woodland. Dahl's on Ingersoll is just not limited to the North of Grand Neighborhood, it encompasses the entire City. Therefore, she will support the new plan.

Will Page stated the staff recommendation includes a list of the guidelines for convenience stores that the new plan does not meet. He suggested that these design standards are construed as minimal standards. The minimum open space requirement is not satisfied. The bay opening for carwash is oriented in the wrong direction. They do not meet the light trespass standard and we also heard that the façade width along Ingersoll is less than another standard that was mentioned. Therefore, he agreed with Mr. Jones that this is a congested area to begin with and Dahl's is trying to put too much on the site than really can fit. He will not support the new plan.

Leisha Barcus stated the original plan was approved as a PUD because it included significant neighborhood pedestrian commercial elements and the City is losing that in the new plan. The City is losing the neighborhood elements but everything that the surrounding greater neighborhood desires (the convenience store and the gas station) is included in the old plan. So if P&Z votes against the new plan it is not voting against Dahl's completing the PUD that was agreed to. We will still have a convenience store, we will still have a gas station, and we will have the neighborhood pedestrian feel that the original plan intended. In addition, while the Meta Bank does not look so nice right now, she does not believe that it will never sell. If it does not sell to Dahl's, it will be a very marketable property for the future and the City will still have control over that property and making it a "NPC" commercial building. Therefore, the original PUD gives everything the

neighborhood wants and the new plan is not necessary. The North of Grand neighborhood has the most impact for her and they want to keep the original plan and do not want the new plan. Therefore, she will be voting against the new plan.

Jeffrey Johannsen stated he would like to see this project go through. With the economy he knows that if you don't compete you are out of business and would hate to see Dahl's move out of this area. At one time Dahl's did talk about moving out of this area. He will vote in favor of this project. However, he does have some concern about the turnaround with parking and deliveries and he is not so sure about the carwash. He thinks that they are trying to put too much in one spot and thinks there needs to be a compromise.

JoAnne Corigliano stated the only thing she can see that would help the problem is the cul-de-sac on 34th Street. There has been a lot of compromise; the convenience store and the bank are a much smaller footprint. Parking is an issue for a store this size. They must have parking otherwise they cannot do business. She will vote for the new plan because she sees the only thing that needs to be done is to block 34th Street.

Joel Huston stated he appreciates everyone coming out and voicing their concerns and that Dahl's have met with the neighbors and tried to address their concerns. His concerns are nearly identical to Jeffrey Johannsen. Therefore, he will be supporting this plan.

Ted Irvine stated he is concerned about discounting the other businesses in the area and what the other neighborhoods think. Dahl's/Larry James Jr. has included the neighborhoods, has spent a lot of time meeting with the North of Grand neighborhood and has tried to come up with things that might be a reasonable compromise. Dahl's is trying to get the greatest economic impact out of the property they have. Dahl's does not own that Meta Bank property today. Ted is part of the Restoration Ingersoll. They took a look at the new plan versus the approved PUD and felt it was very consistent with the restoration project and the Westside Chamber of Commerce saw it the same way. Dahl's is trying to work with the neighbors and to address their concerns, and thinks the cul-de-sac has merit. He made a motion to approve the new plan with no changes.

Kent Sovern asked the Commission can he allow Larry James Jr. to answer one more question.

Mike Simonson asked if the convenience store and the bank was located on the 35th Street corner and the carwash remained as proposed on the new plan, would Dahl's support that.

Larry James Jr. stated no, Dahl's would not support locating the convenience store and the bank on the 35th Street corner.

Mike Simonson asked Mr. Irvine if he could offer a friendly amendment to the motion:

1. The access from the site to 34th needs to be two-way traffic.
2. The City Traffic Engineer should consider no parking along Ingersoll in front of the apartment building.
3. There should be a "NO TRUCK" sign on Woodland Avenue.
4. There should be a curb cut break on the Ingersoll entrance drive for immediate access to the gas pumps.
5. The architecture of the bank should be differentiated from the look of the convenience store.

Ted Irvine stated that he agrees to the friendly amendment as long as the applicant agrees.

Larry James Jr. stated the applicant agrees to the proposed friendly amendment.

Kent Sovern stated that he preferred the original proposal. However, he will support the new proposal.

COMMISSION ACTION

Ted Irvine moved staff recommendation to find the requested rezoning in conformance with the Des Moines' 2020 Community Character Plan.

Motion passed 10-0-1 (Brian Millard abstained)

Mike Simonson asked for a friendly amendment to include the following:

1. The access from the site to 34th needs to be two-way traffic.
2. The City Traffic Engineer should consider no parking along Ingersoll in front of the apartment building.
3. There should be a "NO TRUCK" sign on Woodland Avenue.
4. There should be a curb cut break on the Ingersoll entrance drive for immediate access to the gas pumps.
5. The architecture of the bank should be differentiated from the look of the convenience store.

Motion passed 7-3-1 (Greg Jones, Leisha Barcus, and Will Page were in opposition. Brian Millard abstained)

Ted Irvine moved staff recommendation with the friendly amendment to approve the proposed rezoning and PUD Concept Plan amendment subject to the following conditions:

1. Provision of bike racks near the entrance of the bank.
2. Provision of solid steel gate for any trash enclosure.
3. Restriction of the convenience store and carwash hours of operation from 6:00 A.M. to 11:00 P.M.
4. Use of 60-degree parking stalls where angled parking is designated.
5. Provision of a note that states parking shall be provided for all employees on site.
6. Parapet walls shall have a finished appearance on all sides as approved by the Community Development Director.
7. Provision of functional windows on the south façade of the convenience store to the satisfaction of the Community Development Director.
8. Prohibition of signage on the north façade of the carwash building.
9. Provision of ornamental fencing around the perimeter of the convenience store site along Ingersoll Avenue and 34th Street.
10. Provision of signage and painted pavement markings identifying the 34th Street drive as "entrance only."
11. Realignment of the carwash exit toward the convenience store (south).
12. Submission of written certification from the owner's lighting consultant that all site lighting is installed in accordance with the approved lighting plan and does not exceed 1 foot candle at the property lines prior to issuance of a Certificate of Zoning Compliance.

13. The access from the site to 34th needs to be two-way
14. The City Traffic Engineer should consider no parking along Ingersoll in front of the apartment building
15. There should be a "NO TRUCK" sign on Woodland Avenue
16. There should be a curb cut break on the Ingersoll entrance drive for immediate access to the gas pumps.
17. The architecture of the bank differentiated from the look of the convenience store.

Motion passed 6-4-1 (Greg Jones, Leisha Barcus, Mike Simonson, and Will Page were in opposition. Brian Millard abstained)

Respectfully submitted,

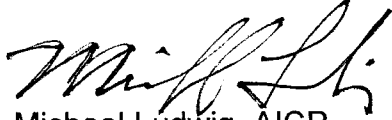

Michael Ludwig, AICP
Planning Administrator

MGL:clw

Attachment

Date 4-26-10

Agenda Item 57

Roll Call # _____

**Traffic Impact Study Update:
Dahl's PUD – Ingersoll Avenue and 35th Street**

Draft Report

March 23, 2010

Completed For:

Food's Inc.

By:



Howard R. Green Company

Table of Contents

INTRODUCTION	1
<i>Purpose and Study Objective</i>	<i>1</i>
BACKGROUND	1
<i>Study Location</i>	<i>1</i>
<i>Existing Conditions</i>	<i>2</i>
Existing Traffic Volumes	<i>3</i>
<i>Planned Roadway Improvements</i>	<i>3</i>
Proposed Land Use	3
<i>Trip Generation</i>	<i>4</i>
Trip Reduction Calculations	<i>5</i>
<i>Trip Distribution</i>	<i>6</i>
Intersection Capacity Analysis	7
Site Circulation Review	9
<i>Parking Requirements</i>	<i>10</i>
Conclusions	11
Appendix A – Final Traffic Impact Study (January 2008)	A
Appendix B – City Review Comments Rec'd on Original Draft	B

List of Exhibits

Exhibit 1 – Study Location Map	1
Exhibit 2 – Project Study Area Aerial	2
Exhibit 3 – Existing Peak Hour Traffic Volumes	3
Exhibit 4 – Updated Dahl's P.U.D. Site Plan (3/18/2010).....	4
Exhibit 5 – Trip Generation Table from Original Study.....	5
Exhibit 6 – Trip Generation Table using ITE Trip Generation, 8 th Edition	5
Exhibit 7 – Updated Trip Generation Table.....	5
Exhibit 8 – Pass-By Trip Percentages	6
Exhibit 9 – Opening Day PM Peak Hour Traffic Projections.....	7
Exhibit 10 – Level of Service vs. Control Delay (unsignalized intersections).....	8
Exhibit 11 – Level of Service vs. Control Delay (signalized intersections).....	8
Exhibit 12 – Ingersoll Avenue & 35 th Street LOS Analysis	9
Exhibit 13 – Unsignalized Intersection LOS Analysis.....	9
Exhibit 14 – Parking Requirements	10

INTRODUCTION

Purpose and Study Objective

This traffic impact study update was conducted in Des Moines, Iowa in response to proposed changes in land use to the Dahl's Planned Unit Development (PUD). The original traffic impact study was completed in January 2008 and included a new supermarket to replace the existing store and a convenience store/gas station. The proposed changes in land use have added a car wash and a bank. This study update will evaluate the impacts of the proposed Dahl's development on the adjacent roadway network and evaluate the operation of the adjacent intersections. This study reviews projected traffic operations of the study area if the site were to develop as proposed.

The objective of this study update is to provide a comparison to the original study completed in January 2008, document the expected impact of the proposed Dahl's development on the local transportation network, and identify necessary improvements.

BACKGROUND

Study Location

The proposed development is located along the north side of Ingersoll Avenue between 34th and 35th Streets. **Exhibit 1** shows the study location with respect to the City of Des Moines.

Exhibit 1 – Study Location Map

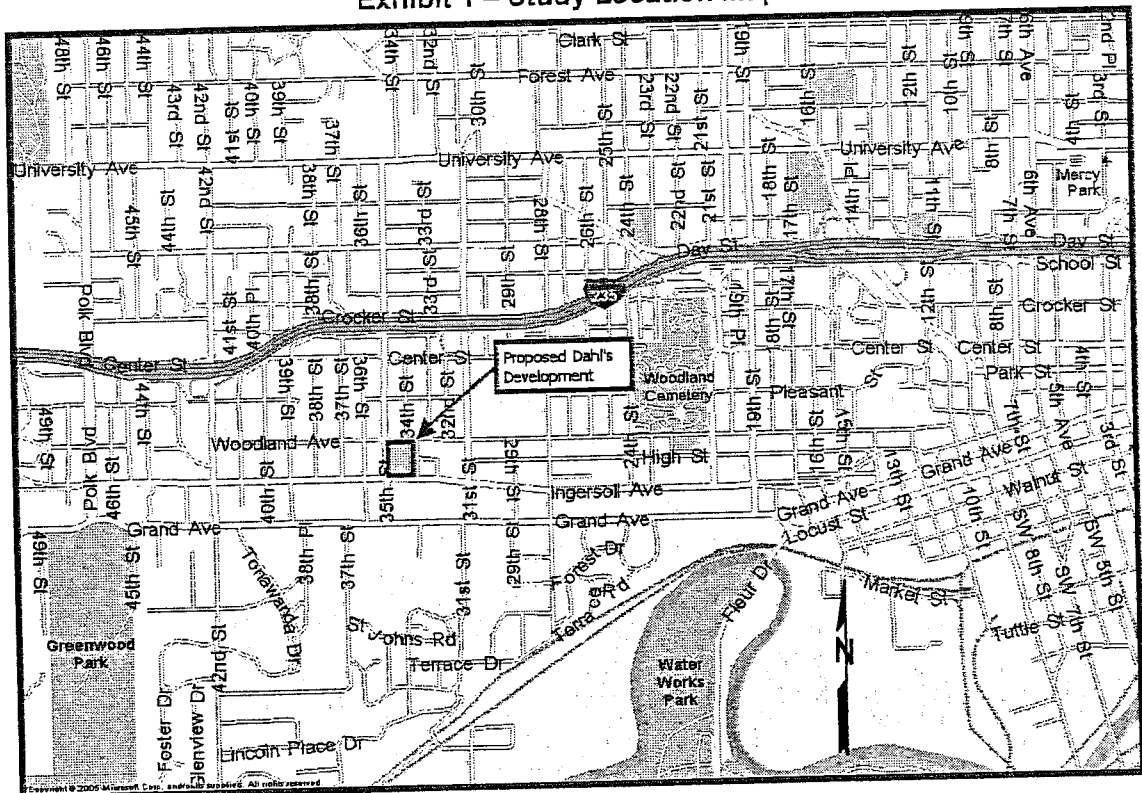

The project study area is bounded by Woodland Avenue on the north, 34th Street on the east, 35th Street on the west, and Ingersoll Avenue on the south. Intersections included in the analysis of this proposed development include the following:

- Ingersoll Avenue & 35th Street,
- Ingersoll Avenue & 34th Street,
- 35th Street & Woodland Avenue, and
- Proposed access points to the development.

Exhibit 2 shows an aerial view of the project study area.

Exhibit 2 – Project Study Area Aerial

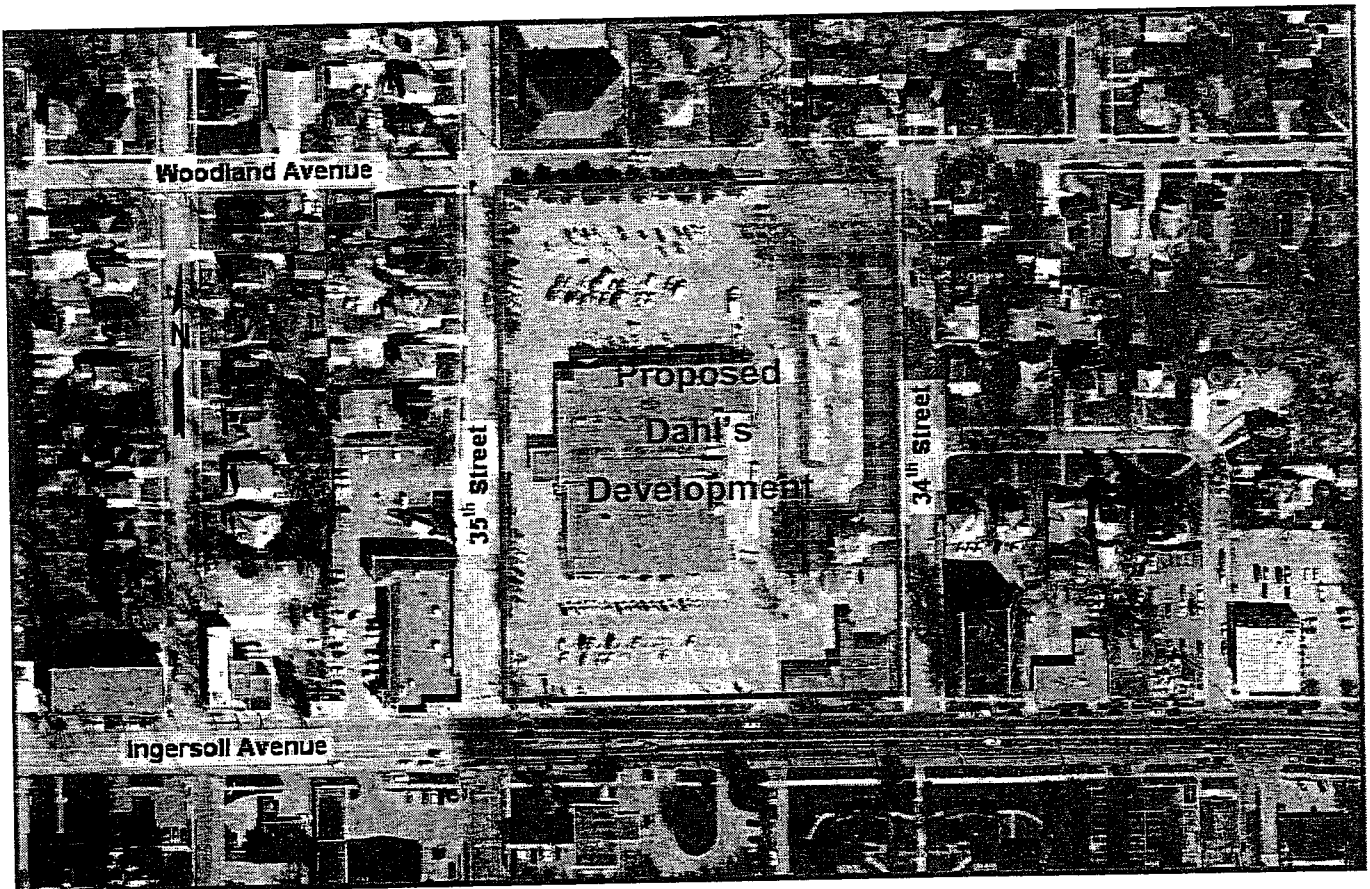

Existing Conditions

Currently, Ingersoll Avenue is a 4-lane roadway with left turn lanes at 35th Street. 34th Street is a 2-lane roadway that forms a t-intersection with Ingersoll Avenue. 35th Street is a 2-lane roadway with left turn lanes at Ingersoll Avenue. Woodland Avenue is also a 2-lane roadway. The intersection of Ingersoll Avenue and 35th Street is signalized. The 35th Street/Woodland Avenue and Ingersoll Avenue/34th Street intersection are both stop controlled. Ingersoll Avenue has a posted speed limit of 30 mph.

Existing Traffic Volumes

Manual turning movement traffic counts were completed as part of the original study. These counts were conducted on December 18, 2007 and included the AM (7-9) and PM (4-6) peak hours. Additional traffic counts were not conducted as a part of this study update. **Exhibit 3** shows the existing AM and PM peak hour traffic volumes at the study intersections.

Exhibit 3 – Existing Peak Hour Traffic Volumes

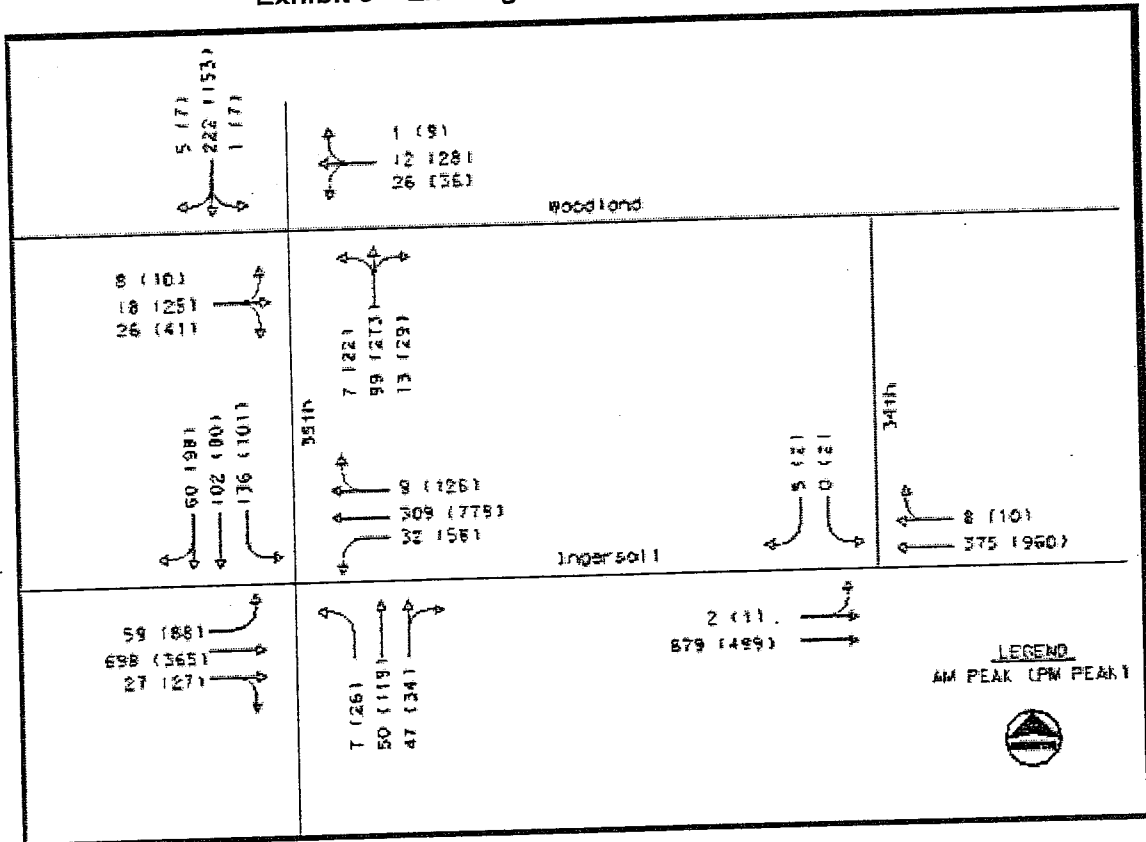

Planned Roadway Improvements

Since the time of the original January 2008 study, the city has completed a study of the Ingersoll Avenue corridor and is moving forward with an alternative which will restripe Ingersoll Avenue from its current 4-lane capacity to a 3-lane roadway with center two-way left-turn lane. This change is being done on a trial basis with the city completing before and after studies to compare the traffic operations along the corridor. For this reason, additional analysis has been completed as part of this update to show the anticipated traffic operations with both the 4-lane and 3-lane scenarios.

Proposed Land Use

The updated site plan moves the proposed convenience store land use from the southwest quadrant of the development to the southeast quadrant and now includes a carwash associated with the convenience store. Additionally, a bank is now proposed in

the southwest quadrant, replacing the original location of the convenience store. The updated site plan is shown in Exhibit 4.

Exhibit 4 – Updated Dahl's P.U.D. Site Plan (3/18/2010)

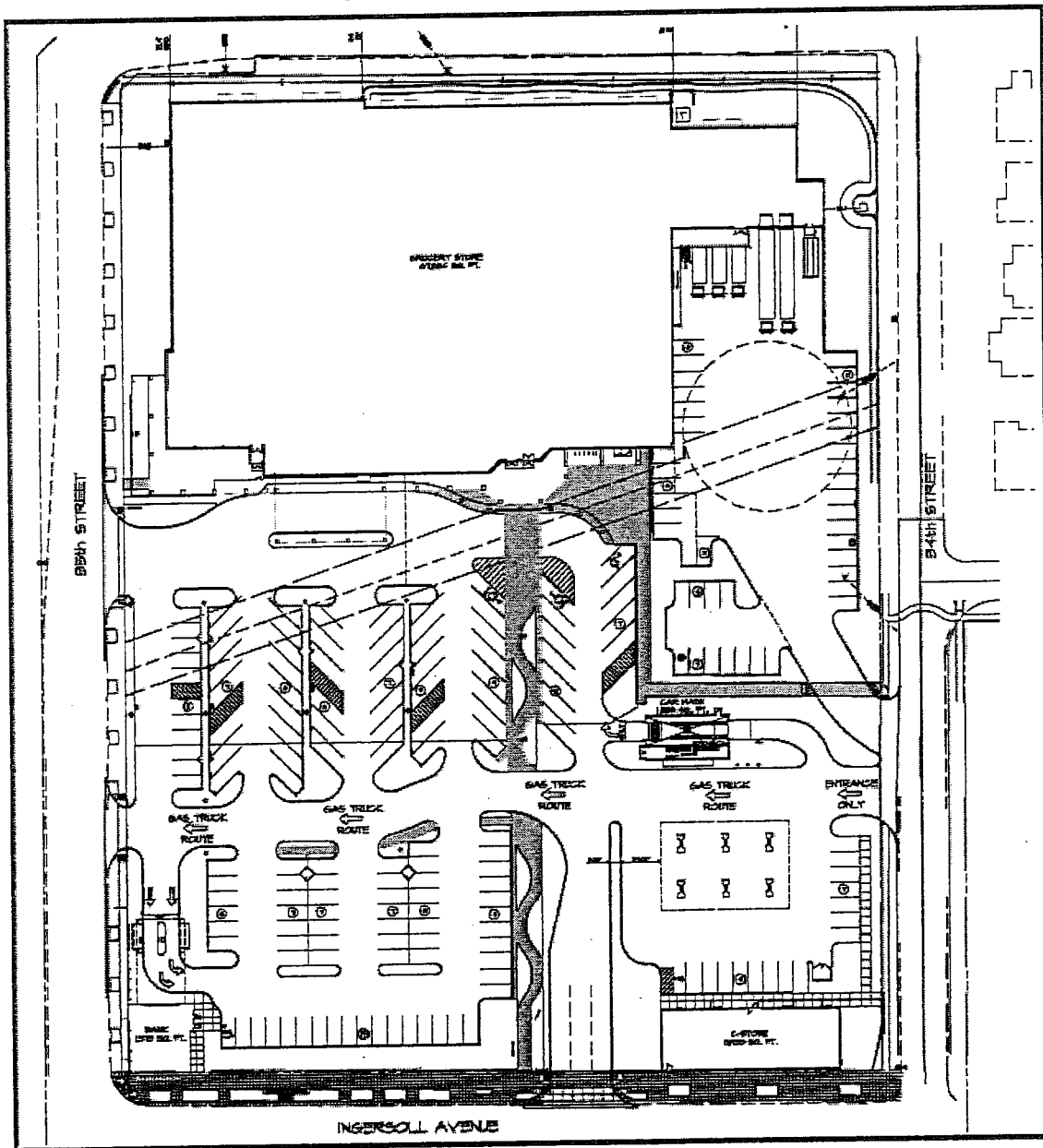

Trip Generation

The January 2008 traffic impact study used trip generation rates as published in the *Institute of Transportation Engineers (ITE) Trip Generation, 7th Edition*. Since the time of the original study, ITE has published the 8th edition of Trip Generation. Exhibit 5, on the following page, shows the trip generation table from the January 2008 report.

Exhibit 5 – Trip Generation Table from Original Study

Land Use Description	Square Feet	Vehicle Fueling Positions	Daily Trips Entering	Daily Trips Exiting	AM Peak Trips Entering	AM Peak Trips Exiting	PM Peak Trips Entering	PM Peak Trips Exiting
Supermarket	69885		3573	3573	139	89	372	358
Gasoline/Service Station with Convenience Market	3600	12	977	977	60	60	60	80
			4549	4549	199	149	433	438

Exhibit 6 calculates the anticipated trips generated by the originally planned land uses utilizing the trip generation rates contained in the 8th Edition.

Exhibit 6 – Trip Generation Table using ITE Trip Generation, 8th Edition

Land Use Description	Square Feet	Vehicle Fueling Positions	Daily Trips Entering	Daily Trips Exiting	AM Peak Trips Entering	AM Peak Trips Exiting	PM Peak Trips Entering	PM Peak Trips Exiting
Supermarket	69885		3573	3573	153	98	374	360
Gasoline/Service Station with Convenience Market	3600	12	977	977	60	60	60	80
			4549	4549	213	158	435	440

The change in trip generation rates between the 7th and 8th Editions resulted in a slight increase in the AM and PM peak hour trips. The AM peak hour had 23 additional trips (14 entering + 9 exiting) while the PM peak hour had 4 additional trips (2 entering + 2 exiting). The total daily trips were unchanged.

Exhibit 7 shows the anticipated trip generation for the updated site plan using the 8th Edition trip generation rates.

Exhibit 7 – Updated Trip Generation Table

Land Use Description	Square Feet	Vehicle Fueling Positions	Daily Trips Entering	Daily Trips Exiting	AM Peak Trips Entering	AM Peak Trips Exiting	PM Peak Trips Entering	PM Peak Trips Exiting
Supermarket	67854		3469	3469	149	95	363	349
Gasoline/Service Station with Convenience Market and Car Wash	3635	12	917	917	64	64	60	80
Drive-in Bank	1573		117	117	11	9	20	20
			4502	4502	223	167	464	449

Comparing Exhibits 6 and 7, the total daily trips entering and exiting the site have decreased by 94 trips (47 entering + 47 exiting) while the AM and PM peak hours both increased by 19 trips (10 entering + 9 exiting in the AM and 9 entering + 10 exiting in the PM). This analysis provides the comparison of the previously proposed land uses with the newly proposed land uses utilizing the most recently published trip generation rates. The analysis shows that with the addition of the bank and carwash to the site, the overall trips generated by the site are not anticipated to increase significantly. This is partially due to a reduction in the size of the Dahl's store by approximately 2,000 square feet with the updated plan.

Comparing Exhibits 5 and 7 again shows a reduction in the total daily trips entering and exiting the site by 94 trips (47 entering + 47 exiting). The AM peak hour increased by 42 total trips (24 entering + 18 exiting) while the PM peak hour increased by 22 total trips (11 entering + 11 exiting). This analysis provides the comparison of the original trip generation calculations contained in the January 2008 study which utilized the trip generation rates from the 7th Edition with the newly proposed land uses utilizing trip generation rates from the 8th Edition. This analysis again shows that with the addition of the bank and carwash to the site, the overall trips generated by the site are not anticipated to increase significantly.

Trip Reduction Calculations

Given the nature of the site, the number of trips generated may be reduced by an internal capture percentage. The internal capture methodology is a procedure described

in ITE's *Trip Generation Handbook* for use when analyzing multi-use developments. The methodology allows for the reduction of trip generation for a site based on the possibility of shared trip generation between land uses. For example, while a person's primary destination might be the supermarket land use, the person might also decide to get gas at the convenience mart. Thus, while each land use had the benefit from this person, no additional trips were generated from outside the study area.

Using the methodology in the *Trip Generation Handbook*, the internal capture rate for this site was calculated at 10%. For the PM peak, the resulting number of trips entering and exiting the site are reduced to 417 and 404, respectively.

The anticipated traffic volumes on the roadways surrounding the study area will also be affected by pass-by trips. Pass-by trips are trips that are already on the roadway network. For instance, a person is traveling on one of the adjacent study roadways on their way home from work. This person decides to stop by for groceries on their way home. This person was already on the roadway adjacent to the site and does not represent a new trip. Pass-by-trips are made as intermediate stops on the way from an origin to a primary route destination without a route diversion.

The pass-by trip percentages for each of the proposed land uses are shown in **Exhibit 8** as referenced from *ITE's Trip Generation Handbook*.

Exhibit 8 – Pass-By Trip Percentages

Land Use	%
Supermarket	36%
Gasoline/Service Station with Convenience Market	56%
Drive-In Bank	47%

While this percentage does not represent a true reduction in the trip generation of the site, it reduces the overall impact of the site on the roadway network by redirecting vehicles which were already on adjacent roadways to the proposed development.

Trip Distribution

Due to the relocation of the planned land uses with the updated site plan, the trip distribution process was recalculated from the original study to include the newly proposed land uses and account for site changes. Trip assignments were based on assumed travel behaviors, location of trip destinations on site, and accessibility from/to various routes considering normal travel patterns.

From the PM peak hour traffic counts completed in the study area, the following observations were made and applied during the trip distribution process:

- Approximately 70% of the traffic passing the site is on Ingersoll Avenue with 60% of this being westbound traffic.
- Approximately 30% of the traffic passing the site is on 35th Street with 54% of this being northbound traffic.

The trips generated by the proposed site development were added to the background traffic volumes to determine the opening day traffic projections shown in **Exhibit 9** on the following page.

Exhibit 9 – Opening Day PM Peak Hour Traffic Projections

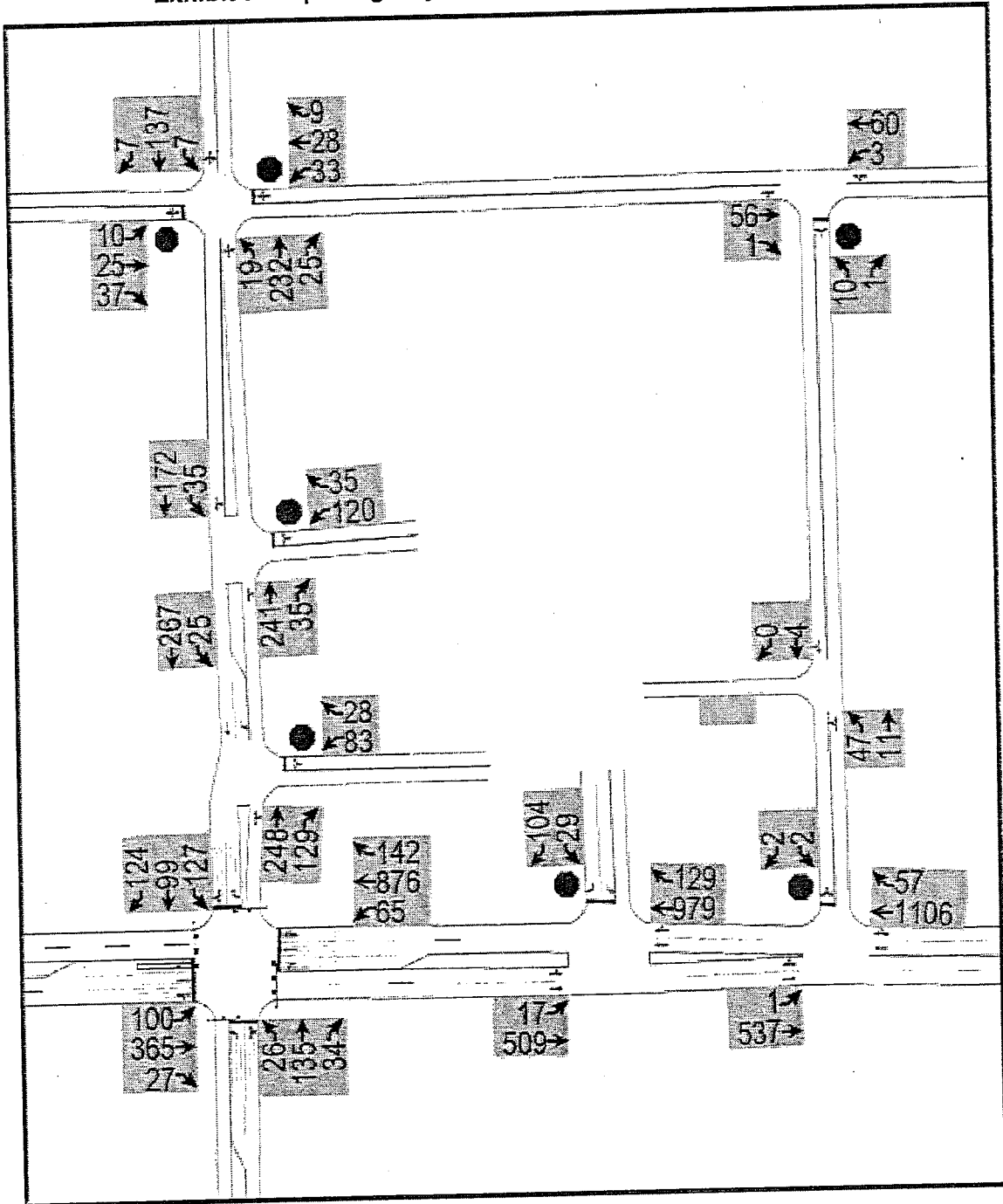

Intersection Capacity Analysis

Level of service (LOS) at intersections is primarily a function of peak hour turning movement volumes, intersection lane configuration, and traffic control. For intersection analysis, the Highway Capacity Manual (HCM) defines LOS in terms of the average control delay at the intersection in seconds per vehicle. The results of an HCM analysis

are typically presented in the form of a letter grade (A-F) that provides a qualitative estimate of the operational efficiency or effectiveness of the corridor. Much like an academic report card, LOS A represents the best range of operating conditions (i.e., motorists experiencing little delay or congestion) and LOS F represents the worst (i.e., extreme delay or severe congestion). **Exhibit 10** defines the control delay range corresponding to each LOS for unsignalized intersection locations.

Exhibit 10 – Level of Service vs. Control Delay (unsignalized intersections)

Level of Service	Average Control Delay (s/veh)
A	≤10
B	>10 and ≤15
C	>15 and ≤25
D	>25 and ≤35
E	>35 and ≤50
F	>50

Exhibit 11 defines the control delay range corresponding to each LOS for signalized intersection locations.

Exhibit 11 – Level of Service vs. Control Delay (signalized intersections)

Level of Service	Average Control Delay (s/veh)
A	≤10
B	>10 and ≤20
C	>20 and ≤35
D	>35 and ≤55
E	>55 and ≤80
F	>80

Synchro, Version 7, Software was used to complete the capacity analysis of the study area intersections. Intersection Level-of-Service results were recorded using Synchro's HCM reporting function.

As mentioned previously, the City of Des Moines is proposing to re-stripe Ingersoll Avenue from its current 4-lane geometry to a 3-lane cross section with center two-way left-turn lane. The analysis of the signalized Ingersoll Avenue/35th Street intersection

was completed using both lane scenarios for comparison purposes. The Level-of-Service results for this intersection are shown in Exhibit 12.

Exhibit 12 – Ingersoll Avenue & 35th Street LOS Analysis

Scenario	Overall	EBL	EBT	EBR	WBL	WBT	WBR	NBL	NBT	NBR	SBL	SBT	SBR
Existing PM Peak	B	A	B		A	B		B	B		B	A	
PM Peak with Redevelopment Existing Ingersoll 4-Lane	B	A	A		A	B		B	B		B	B	
PM Peak with Redevelopment Proposed Ingersoll 3-Lane	D	C	A		A	D		C	C		E	D	

Similar to the results shown in the original January 2008 study, the overall PM peak hour Level-of-Service is not expected to change with the current 4-lane Ingersoll Avenue geometry. With the proposed 3-lane geometry, the overall intersection Level-of-Service is D, which is typically considered acceptable in an urban situation.

The Level-of-Service comparison of the unsignalized intersections is shown in Exhibit 13.

Exhibit 13 – Unsignalized Intersection LOS Analysis

Intersection	NB	SB	WB	EB
Existing Conditions				
Woodland and 35th	A	A	C	B
Ingersoll and 34th		C		B
With Redevelopment				
Woodland and 35th	A	A	C	B
Ingersoll and 34th		C		B
35th North Access		A	B	
35th South Access		A	C	
Ingersoll Access		D		B

The results show that the unsignalized locations, including the access drives to the development, are operating at acceptable levels with Level-of-Service D or better for all approaches.

Site Circulation Review

The following observations were made with respect to traffic circulation in and around the proposed site:

- The proposed site plan shows an entrance only access point along 34th Street on the east side of the development. While this access point was analyzed as an entrance only during the capacity analysis, it is likely that a portion of the trips generated by the site may try to exit from this location. However, given the nature of the surrounding street network, those vehicles exiting from this location and traveling north are likely to be local residents.
- The proposed carwash exit is shown to be right-out only. Even with proper signing, it is likely that some vehicles will make the left-turn leaving

this facility. This could pose a potential conflict for vehicles backing from parking stalls in this area.

- Large trucks entering the Dahl's loading bay area on the east side of the store may have difficulty performing a u-turn maneuver in the area provided if vehicles are parked in this area. While a turning movement analysis was not completed as part of this report, this condition may lead the large trucks to access the site by traveling southbound on 34th Street and backing into the loading bay area rather than making the u-turn maneuver. It is recommended that Dahl's work to coordinate their deliveries and inform delivery companies of the proper way to access their site.
- The City of Des Moines Municipal Code Section 134-1377 states that financial institutions without walkup facilities should provide 3 vehicle stacking spaces per teller. The available vehicle stacking area shown on the current site plan appears to be slightly less than 3 vehicles. Vehicles queued in this location could potentially block the proposed south access location along 35th Street.

Parking Requirements

The City of Des Moines Municipal Code was referenced to determine the parking requirements for the proposed development. Section 134-1377 of this code states "In all zoning districts, except the PUD, NPC and C-3 districts, in connection with every industrial, commercial, business, trade, institutional, recreational, or dwelling use and similar uses, space for parking and storage of vehicles shall be provided in accordance with the schedule in this subsection." Section 134-693 states "Off-street parking and loading will be provided as appropriate to the size and character of the proposed development". Given that the planned development is zoned Planned Unit Development (PUD), the specific requirements of section 134-1377 are not applied directly. Rather, the parking requirements for this type of development are established through the coordinated efforts of the City and the developer. That being said, the parking requirements described in section 134-1377 have been used to determine the minimum parking stalls provided for the proposed development if it were not zoned as a PUD. For comparison purposes, these requirements have also been compared to the requirements for Neighborhood Pedestrian Commercial (NPC) districts which require 60% of the parking requirements described by section 134-1377. These calculations are shown in Exhibit 14.

Exhibit 14 – Parking Requirements

Land Use	Building Sq. Ft.	Section 137-1377 Requirements	Parking Required	NPC Requirements (60%)
Supermarket	67854	1 / 200 sq. ft.	339	204
Convenience Market	3935	1 / 300 sq. ft.	13	8
Drive-In Bank	1573	1 / 400 sq. ft. (minimum 5)	5	3
Total Required			357	214

4000 - 10 stalls
63854 - 319
67,854 - 329

The parking lot layout has not been finalized at the time of this report. However, information from the developer indicates that with 45° angle parking, there would be 192 spaces provided on the site. The developer is investigating the possible use of 60°

angle parking which would add approximately 14 spaces bringing the total number of spaces provided up to 206. This total is less than the requirements of Section 134-1377 and slightly less than that required by the NPC regulations. However, given that the area is zoned PUD, the actual parking requirements will need to be coordinated between the City and the developer.

Conclusions

The changes proposed with the updated site plan are not expected to have negative impacts on the overall operation of City intersections adjacent to the site. Trip generation calculations show that the land uses associated with the updated site plan are anticipated to increase the PM peak hour trips by approximately 19 trips (using current ITE trip generation rates) over what was planned as part of the original January 2008 report. The capacity analysis of the study area intersections showed that all intersections are expected to operate at acceptable levels given the opening day traffic projections.

Draft Report
March 23, 2010

Traffic Impact Study Update
Dahl's PUD – Ingersoll Avenue

Appendix A – Final Traffic Impact Study (January 2008)

Date 4-26-10

Agenda Item 57

Roll Call # _____

Traffic Impact Study

Dahl's Store – Ingersoll Avenue and 35th Street

Des Moines, IA

January 2008

Completed For:

Food's Inc.

By:



Howard R. Green Company

Table of Contents

INTRODUCTION.....	3
BACKGROUND	3
EXISTING TRAFFIC COUNTS	4
PROPOSED LAND USE	5
TRIP GENERATION AND DESIGN HOUR VOLUMES.....	6
TRIP DISTRIBUTION AND ASSIGNMENTS.....	7
INTERSECTION ANALYSIS	8
CONCLUSIONS.....	9

List of Exhibits

Exhibit 1 – Site Location.....	3
Exhibit 2 – Existing Counts.....	4
Exhibit 3 – Proposed Site Plan	5
Exhibit 4 – Existing Use Trip Generation	6
Exhibit 5 – Proposed Land Use Trip Generation.....	6
Exhibit 6 – Trip Distribution.....	7
Exhibit 7 – Level of Service Analysis – 35 th and Ingersoll	8
Exhibit 8 – Level of Service Stop Control – Existing Volumes.....	8
Exhibit 9 – Level of Service Stop Control – Full Development Volumes.....	9

INTRODUCTION

Project Description

This report identifies and evaluates the proposed changes to the existing site land uses. The study area contains approximately 5.6 acres of land located within the city limits of Des Moines. Dahl's Foods currently operates an existing supermarket type land use in the study area (located at 3425 Ingersoll Avenue). The existing structure is approximately 49,000 square feet in size. Dahl's proposes building a new facility at the same location with a supermarket land use of approximately 69,900 square feet as well as a gasoline/convenience mart on the premises.

BACKGROUND

Land Use, Site and Study Area Boundaries

The study area is located south of Interstate 235 in the City of Des Moines. It is bounded by Woodland Avenue on the north; 34th Street on the east; 35th Street on the west and Ingersoll Avenue on the south. The study area is illustrated in **Exhibit 1**.

Exhibit 1 – Site Location

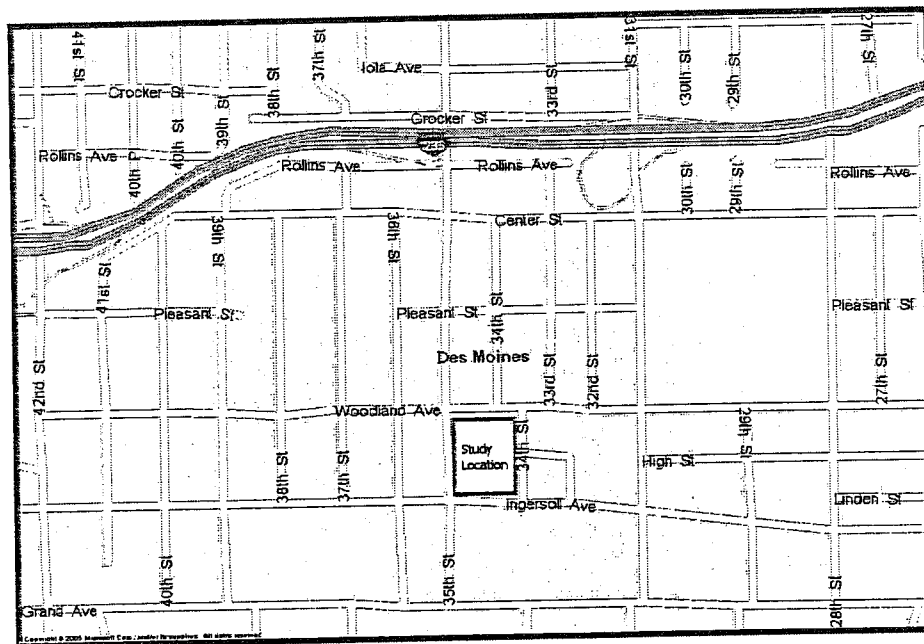

Study Objective and Procedures

This study measures the effect the proposed land use changes have on the local roadway network and identifies necessary improvements. The analysis includes the review of the site plan for parking lot circulation and comparing the existing trip generation for the site to the proposed land uses. In addition, a review of the truck delivery circulation patterns was completed. The number of trips generated by the existing and proposed uses was determined using the *Trip Generation, 7th Edition*, published by the Institute of Transportation Engineers (ITE).

EXISTING TRAFFIC COUNTS

Howard R. Green Company completed traffic counts on December 18, 2007. The manual turning movement counts were taken during the peak hours of 7-9 AM and 4-6 PM and were completed at the following intersections:

- Ingersoll Avenue and 35th Street
- Ingersoll Avenue and 34th Street
- Woodland Avenue and 35th Street

The peak hour traffic volumes are shown in Exhibit 2.

Exhibit 2 - Existing Counts

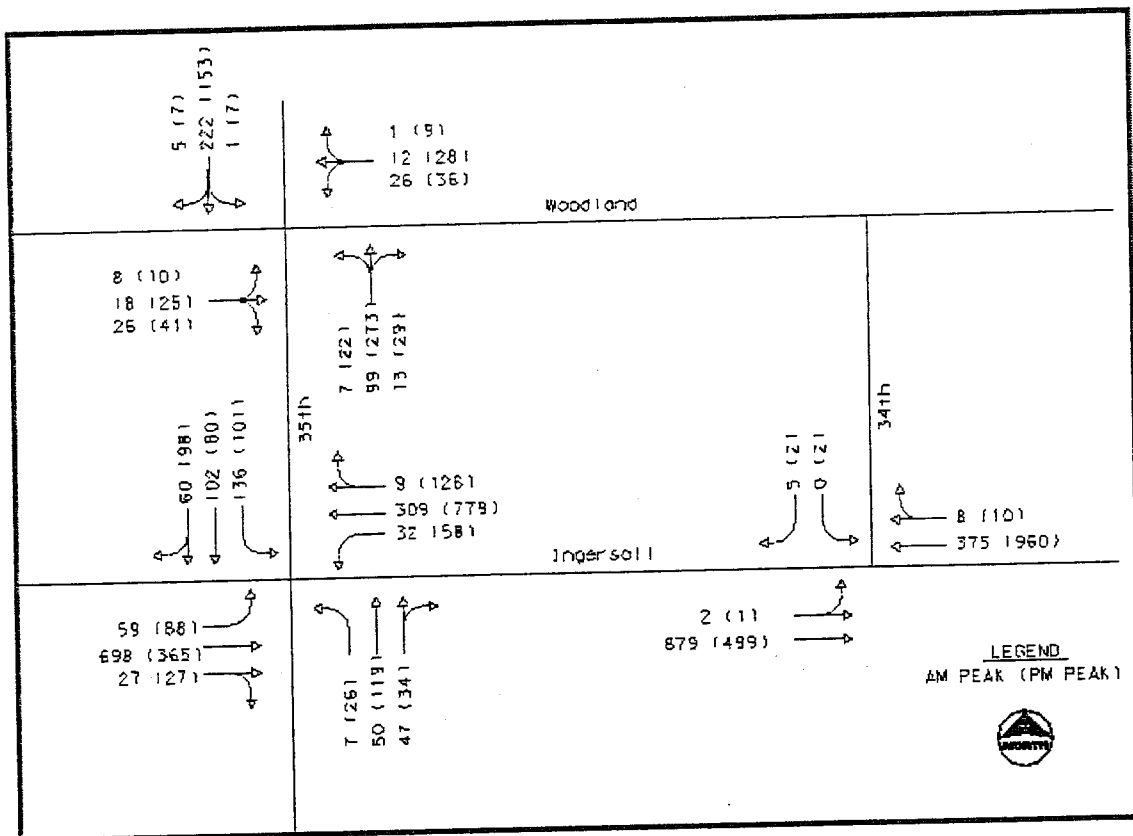

Ingersoll Avenue is a 4-lane roadway with left turn lanes at 35th Street. 34th Street is a 2-lane roadway that forms a t-intersection with Ingersoll Avenue. 35th Street is a 2-lane roadway with left-turn lanes at Ingersoll Avenue. The intersection of 35th Street and Ingersoll Avenue is signalized. Woodland Avenue is a 2-lane roadway.

PROPOSED LAND USE

The proposed site plan consists of a new Dahl's Store and a convenience store. The proposed site plan is shown in Exhibit 3.

Exhibit 3 - Proposed Site Plan

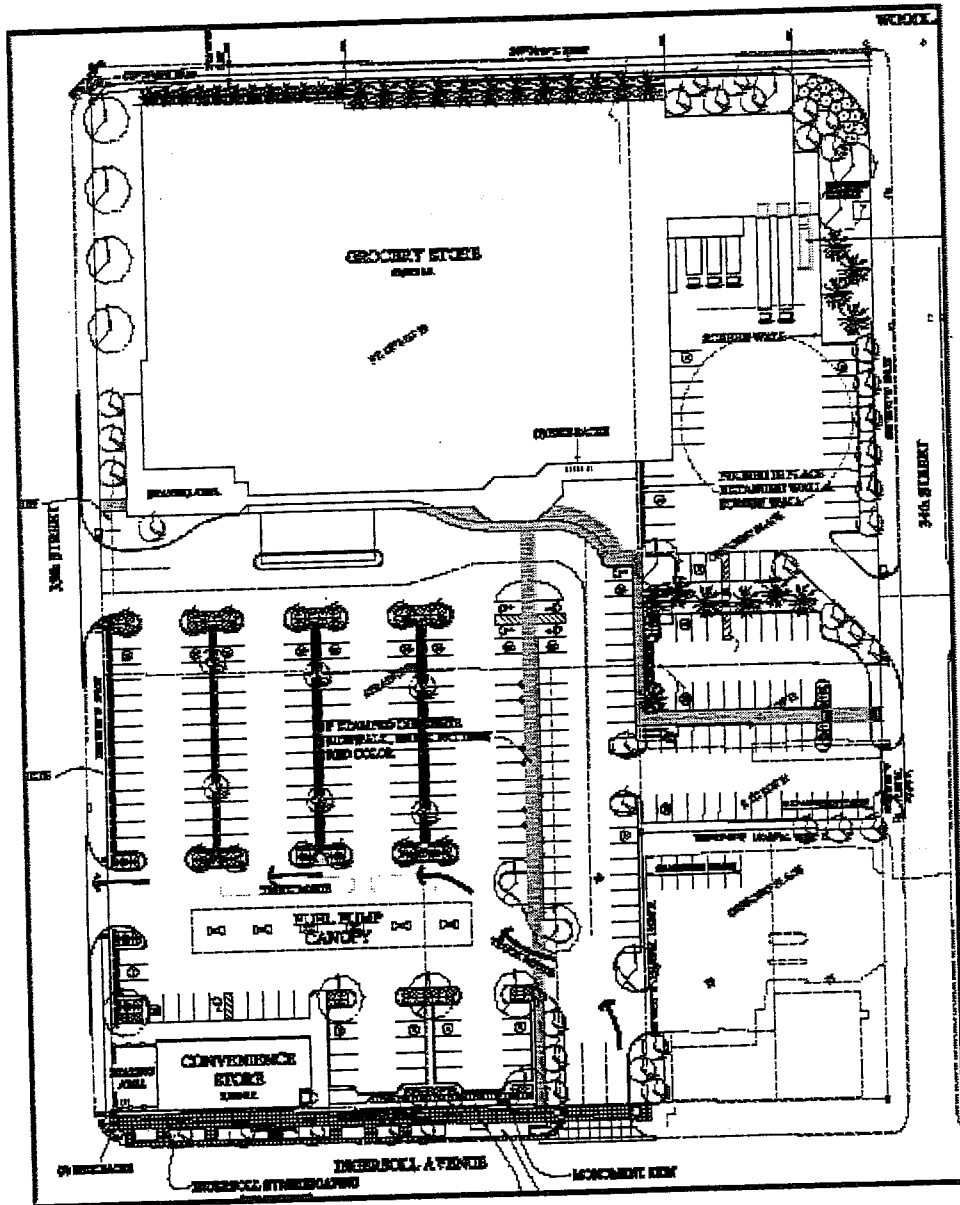

TRIP GENERATION AND DESIGN HOUR VOLUMES

Trip generation rates contained in ITE's *Trip Generation, 7th Edition*, were used to develop estimates of trips to and from the site based on the existing land uses. These procedures were also applied to the proposed land uses to determine the potential change in traffic for the study area. Exhibits 4 and 5 show the daily, AM peak hour, and PM peak hour trip generation for the existing and proposed land uses.

Exhibit 4 – Existing Use Trip Generation

EXISTING USE TRIP GENERATION							
USE	SQ FT	ADT		AM Peak		PM Peak	
		Entering	Exiting	Entering	Exiting	Entering	Exiting
Supermarket	49,000	2,505	2,505	97	62	261	251

Exhibit 5 – Proposed Land Use Trip Generation

PROPOSED LAND USE TRIP GENERATION							
USE	SQ FT	ADT		AM Peak		PM Peak	
		Entering	Exiting	Entering	Exiting	Entering	Exiting
Supermarket	69,885	3573	3573	139	89	372	358
Gasoline/Service Station with Convenience Market	3,600	977	977	60	60	80	80
Total		4,549	4,549	199	149	453	438

As is shown in the tables, the proposed additional building square footage and the addition of the convenience store to this site is anticipated to almost double the number of trips entering and exiting the site on a daily basis. However, given the nature of the site, the number of trips generated may be reduced by an internal capture percentage. The internal capture methodology is a procedure described in ITE's *Trip Generation Handbook* for use when analyzing multi-use developments. The methodology allows for the reduction of trip generation for a site based on the possibility of shared trip generation between land uses. For example, while a person's primary destination might be the supermarket land use, the person might also decide to get gas at the convenience mart. Thus, while each land use had the benefit from this person, no additional trips were generated from outside the study area.

Using the methodology in the *Trip Generation Handbook*, the internal capture rate for this site was calculated at 10%. For the PM peak, the resulting number of trips entering and exiting the site are reduced to 408 and 394, respectively.

The anticipated traffic volumes on the roadways surrounding the study area will also be affected by pass-by trips. Pass-by trips are trips that are already on the roadway network. For instance, a person is traveling on one of the adjacent study roadways on their way home from work. This person decides to stop by for groceries on their way home. This person was already on the roadway adjacent to the site and does not represent a new trip. Pass-by-trips are made as intermediate stops on the way from an origin to a primary route destination without a route diversion. For the supermarket land use, the pass-by rate is 36% and 56% for the gas station with convenience market. While this percentage does not represent a true reduction in the trip generation of the site, it reduces the overall impact of the site on the roadway network by redirecting vehicles which were already on adjacent roadways to the proposed development.

TRIP DISTRIBUTION AND ASSIGNMENTS

Based on the trip generation of the proposed development, the trip ends were assigned to the entrances/exits of the site. Assignments were based on assumed travel behaviors, location of trip destinations on site, and accessibility from/to various routes considering normal overall travel patterns.

It is assumed that 65% of the trips will use the north entrance on 35th Street, 20% will use the south entrance on 35th Street and the remaining 15% will use the entrance off of Ingersoll Avenue. **Exhibit 6** shows the trip distribution.

Exhibit 6 - Trip Distribution

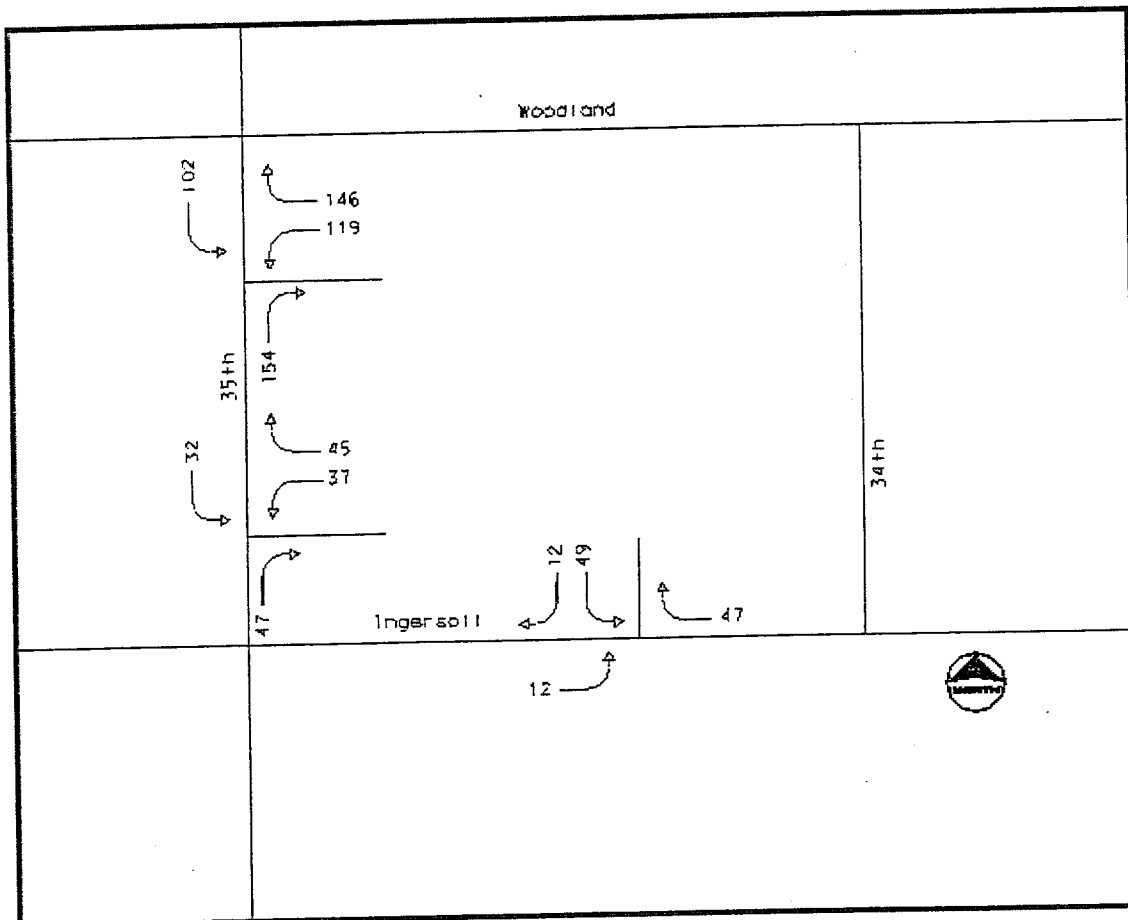

According to Dahl's, this store has approximately 218 truck deliveries per week. There are no Sunday deliveries. Monday, Wednesday and Friday are the peak delivery days with 40 to 50 deliveries on each of those days. Assuming that these deliveries typically occur during normal business hours, this would equate to approximately 5-6 truck deliveries per hour. It is also assumed that these deliveries do not take place during the PM peak hour of traffic.

The truck entrance is located off of 34th Street approximately 175' north of Ingersoll Avenue. The percentage of trucks entering/exiting the site is less than 0.5% of the trips on a daily basis. Because of the location of the truck entrance and the small percentage

of trucks compared to the overall trips, there should not be a significant traffic impact on 34th Street due to the truck deliveries.

Turning template analysis for truck movements was not evaluated with this report.

INTERSECTION ANALYSIS

A PM peak traffic analysis was performed with the trips from the Dahl's site distributed onto the network. Each of the intersections counted were analyzed before and after the proposed development for level of service (LOS).

Level of service (LOS) at intersections is primarily a function of peak hour turning movement volumes, intersection lane configuration, and traffic control. For intersection analysis, the Highway Capacity Manual (HCM) defines LOS in terms of the average control delay at the intersection in seconds per vehicle. The results of an HCM analysis are typically presented in the form of a letter grade (A-F) that provides a qualitative estimate of the operational efficiency or effectiveness of the corridor. Much like an academic report card, LOS A represents the best range of operating conditions (i.e., motorists experiencing little delay or congestion) and LOS F represents the worst (i.e., extreme delay or severe congestion). **Exhibit 7** shows level of service for 35th Street and Ingersoll Avenue for the AM, PM, and PM peak after the development. As can be seen in the table, there is no change in overall LOS before or after the development.

Exhibit 7 – Level of Service Analysis – 35th and Ingersoll

Level of Service Analysis 35th Street and Ingersoll Avenue													
	Overall	EBL	EBT	EBR	WBL	WBT	WBR	NBL	NET	NBR	SBL	SBT	SBR
Existing Volumes - AM Peak	B	B	C		B	B		B	A		B	A	
Existing Volumes - PM Peak	B	A	B		A	B		B	B		B	A	
Full Development Volumes -PM Peak	B	A	B		A	B		B	B		C	A	

Exhibits 8 and 9 shows level of service for the stop controlled intersections and entrances.

Exhibit 8 – Level of Service Stop Control – Existing Volumes

Level of Service Stop Control Intersections - Existing Volumes				
	NB	SB	WB	EB
Woodland and 35th Street	A	A	C	B
Ingersoll and 34th Street		C		B

Exhibit 9 – Level of Service Stop Control – Full Development Volumes

Level of Service Stop Control Intersections - Full Development Volumes				
	NB	SB	WB	EB
Woodland and 35th Street	A	A	D	B
Ingersoll and 34th Street		C		B
North Drive and 35th Street		A	D	
South Drive and 35th Street		A	B	
East Drive and Ingersoll		E		B

As can be seen in the tables for the intersections of Woodland/35th Street and Ingersoll/34th Street, there is very little change in LOS before and after the development. Only the westbound approach for Woodland/35th Street decreases from a LOS C to a LOS D, which is still considered an acceptable level of service in urban areas.

The only entrance that has an unacceptable LOS is the driveway on to Ingersoll Avenue (East Drive). The southbound left will experience approximately 45 seconds of delay (LOS E) during the PM peak hour.

PARKING REQUIREMENTS

According to the P.U.D. Concept Plan, Dahl's is providing 264 parking spaces. A review of Section 134-1377 of the municipal code indicated the number of parking spaces required for this site is approximately 183. The current concept plan exceeds the required number of parking spaces for this site.

CONCLUSIONS

This report has documented the anticipated level of impact of the proposed site development compared to the existing land uses. The proposed development is anticipated to generate higher traffic volumes due to the increased size of the supermarket land use and additional convenience mart land use.

Even though there is an increase in generated traffic from the existing site to the proposed site, this change does not have negative impacts on the overall operation of City intersections adjacent to the site.

Draft Report
March 23, 2010

Traffic Impact Study Update
Dahl's PUD – Ingersoll Avenue

Appendix B – City Review Comments Rec'd on Original Draft

**Traffic Impact Study
Proposed Dahl's - 35th & Ingersoll
December 13, 2007**

Gary L. Fox, P.E.
City Traffic Engineer

We have reviewed the preliminary traffic impact study for the proposed Dahl's store on Ingersoll Avenue at 35th Street, prepared for Dahl's by Howard R. Green Company. We generally concur with the methodology and overall conclusions of the study. Specific comments on various issues addressed in the study are as follows:

Trip Generation and Design Hour Volumes.

We concur with the methodology for the total additional daily trips generated by this proposed development. The total trips are calculated by the trips generated by a supermarket land use plus gasoline station with convenience market and coffee shop (fast food restaurant) with drive-through window. The impacts of the trips on the street network are reduced by the internal capture factor and pass-by trip factor, as well as removal of the trips from the previous supermarket land use on this site.

The net new trips from the proposed redevelopment are not expected to create significant traffic capacity or traffic flow issues. Traffic on 35th Street has been reduced by at least 2,000 vehicles per day (vpd) with the permanent removal of the eastbound exit from I-235 during the reconstruction of I-235. The total net new trips will not increase current traffic volumes on 35th Street back to the level that existed with the freeway ramp connection, and no major congestion or traffic flow problems occurred with that level of traffic.

Overall, the proposed site development plan shows an intense redevelopment of the site. We support a City staff recommendation to reduce the size of the supermarket and to reduce the number of gasoline pumps, which will somewhat reduce the total traffic generated by the site development and also provide opportunity for some additional parking. The final traffic impact study should reflect the final size and configuration of the proposed uses on this site.

Trip Distribution and Assignments.

We concur with the basic assignment of trips in the preliminary study, and will review any proposed changes in the final report. Again, based on our overall knowledge of traffic conditions at this site with the current store, we do not expect significant traffic problems based on the preliminary assignment of trips for the redeveloped site.

We have also reviewed the proposed truck entrance on 34th Street. This entrance has been moved farther south from the original proposed design, which will reduce the impact to adjacent properties on 34th Street. Having trucks use a separate route from the main entrance drive on Ingersoll will substantially reduce truck movement conflicts with both vehicular and pedestrian traffic on this site. The pavement strength and curb radii at

Ingersoll should be further evaluated and improved, if necessary, in accordance with requirements of the City Engineer. The anticipated net new truck volumes should not create any significant traffic flow or capacity problems.

Parking Requirements.

Parking should be provided on-site to meet the parking demand. We believe that the final parking requirement should be higher than regular NPC requirements, as a large supermarket with drive-up coffee shop and convenience store with gas pumps will most likely have less "non-vehicle" customers than many other NPC uses. Again, a reduction in the size of the supermarket and the number of pumps will reduce the total parking demand and provide opportunity for some additional parking spaces.

Site Circulation.

We concur that the first drive on 35th Street north of Ingersoll (south drive of the site) is too close to Ingersoll, and would be impacted by traffic queues on 35th Street. However, rather than close this drive, we recommend moving it approximately 50 feet farther north, so it would line up with the traffic circulation aisle north of the gas pumps. This will reduce the impacts to traffic queues on 35th Street, as well as reduce vehicle/pedestrian conflicts between the gas pumps and convenience store and coffee shop, and also reduce vehicle traffic and pedestrian conflicts in the parking circulation aisles and at the north driveway near the supermarket. The final design of this driveway and internal circulation must accommodate large fuel delivery trucks, but the recommended reduction from six pumps to four should also help provide additional room to accommodate these trucks.

Conclusions.

We have extensive experience with and knowledge of traffic flows along Ingersoll Avenue from several previous studies, including closing of Grand Avenue for construction of ML King, Jr. Parkway, diverted traffic due to reconstruction of I-235 and Ingersoll Avenue Streetscape design. Based on this experience and knowledge, along with the traffic data from the preliminary study, we believe that the surrounding street network has adequate capacity to accommodate the additional traffic from the proposed redevelopment without experiencing substantial negative impacts in level of service. In addition, the existing configuration of the intersection of 35th and Ingersoll is not expected to have any physical changes. We will review the traffic data from the final traffic impact study, and will use this information primarily to determine any needed changes in traffic signal timings or operation to provide the most efficient traffic flow.

Date 4-26-10

Agenda Item 57

Roll Call # _____

Item 2010 00012 ; Date 2/10/10

I (am) in favor of the request.

(Circle One)
RECEIVED
COMMUNITY DEVELOPMENT
FEB 16 2010
Print Name PATRICK FRANKE
Signature Patrick J. Franke
Address 3520 INGERSOLL AVE

DEPARTMENT
Reason for opposing or approving this request may be listed below:

I AM NOT IN FAVOR OF A GAS
CONVIENCE STORE AT THIS LOCATION
DUE TO THE TRASH AND EXTRA
ALCOHOL SALES. INGERSOLL IS
TRYING TO REVITALIZE.

2010 00012

Date 2-11-10

Item

I (am) (am not) in favor of the request.

RECEIVED
COMMUNITY DEVELOPMENT

FEB 16 2010

Print Name Patricia A. Iseminger
Signature Patricia A. Iseminger
Address 654-34 Street

DEPARTMENT

Reason for opposing or approving this request may be listed below:

Proposal will create too much
Traffic for residential Area.
Huge store is already pedestrian
unfriendly (parking is terrible).

Item 2010 00012

Date Feb. 10th, 2010

I (am) (am not) in favor of the request.

RECEIVED
COMMUNITY DEVELOPMENT

FEB 16 2010

Print Name Jennifer Barseth
Signature Jennifer Barseth
Address 3311 Woodland Ave

DEPARTMENT

Reason for opposing or approving this request may be listed below:

There will be too much traffic + noise on the
residential side of the property. Dahl's should
stick to the original plan. Besides, who wants to
walk with groceries to the parking area next to
Ingersoll + 35th it's too far
*I do NOT want 34th ST blocked off.

Item 2010 00012 Date 2-15-10

I (am) (am not) in favor of the request.
(Circle One)

COMMUNITY DEVELOPMENT

FEB 24 2010

DEPARTMENT

Print Name Matt Braafhart

Signature _____

Address 3317 Woodland

Reason for opposing or approving this request may be listed below:

Do not approve of changes, would like Dahls to stick to original approved plan, do not like increased activity on 34th Street and extra traffic that has already been an issue

Item 2010 00012 #4 Date 2.16/10

I (am) (am not) in favor of the request.

RECEIVED
(Circle One)
COMMUNITY DEVELOPMENT

FEB 18 2010

DEPARTMENT

Print Name Thomas Frolick

Signature [Signature]

Address 660 33rd St., Des Moines, IA 50312

Reason for opposing or approving this request may be listed below:

- 1) Environmental Impact - Does Ingersoll need another gas station - there is already an abandoned one and two other functioning stations. Runoff from this station will funnel right into a residential neighborhood.
- 2) Traffic / quality of life - Do you want a gas station on the corner of a residential street?

Item 2010 00012 Date 10 February 2010

I (am) (am not) in favor of the request

RECEIVED
COMMUNITY DEVELOPMENT

Print Name DWIGHT STELLING

Signature Dwight Stelling

FEB 16 2010

Address 662 34th St.

DEPARTMENT

Reason for opposing or approving this request may be listed below:

Item 2010 00012 Date 2/10/10

I (am) (am not) in favor of the request.

RECEIVED
COMMUNITY DEVELOPMENT

Print Name Patrick Taster

Signature Patrick Taster

FEB 16 2010

Address 3315 Woodland Ave

DEPARTMENT

Reason for opposing or approving this request may be listed below:

Would like to stick more with the
original plan + try to keep things
further west in the parking lot.

Item 2010 00012 Date 2-22-10

I (am) (am not) in favor of the request.

(Circle One) RECEIVED
COMMUNITY DEVELOPMENT

Print Name Russell + Stephanie Anderson

Signature Russell Anderson Stephanie Anderson

FEB 26 2010

Address 3308 Woodland Ave

DEPARTMENT

Reason for opposing or approving this request may be listed below:

Concerned with property value and taxes

Item 2010 00012 Date 2/15/10

I (am) (am not) in favor of the request.

(Circle One) RECEIVED
COMMUNITY DEVELOPMENT

Print Name Lynne Beth Hicks

Signature Elizabeth A. Hill

FEB 19 2010

Address 642-33rd St.

DEPARTMENT

Reason for opposing or approving this request may be listed below:

Item 2010 0001245 Date 2/15/10

I (am) (am not) in favor of the request.

(Circle One)

Print Name Susan Houts

RECEIVED
COMMUNITY DEVELOPMENT DEPARTMENT
Signature [Signature]
Address 3325 Crescent Drive

FEB 22 2010

Reason for opposing or approving this request may be listed below:

I want DART'S to stick to the original plan. ~~There~~

Item 2010 00012 Date 2-18-10

I (am) (am not) in favor of the request.

RECEIVED
COMMUNITY DEVELOPMENT DEPARTMENT
Print Name ASH LARSEN
Signature [Signature]
Address 635 34TH ST.

FEB 22 2010

Reason for opposing or approving this request may be listed below:

SHOULD BE ON 35TH - INTERSECTION, NOT 34TH. KEEP AWAY FROM RESIDENTIAL AREA.

Item 2010 00012 Date 2-14-10
 I (am) (am not) in favor of the request.
 RECEIVED
 COMMUNITY DEVELOPMENT DEPARTMENT
 FEB 17 2010
 Print Name Trudi O'Connell
 Signature Mike O'Connell
 Address 637 34th St DSM 50812

Reason for opposing or approving this request may be listed below:

I would like Dahl's to stick to the already existing
Conceptual plan that includes C-stre / 10 fueling
pumps in the SW Portion of the site. 35 + Ingersoll
(Business Intersection, Regulated by a light.)
with NPC/Pud plans) Approved by P+Z + City Council
Feb. 2008.

Item 2010 00012 Date 2/14/10
 I (am) (am not) in favor of the request.
 RECEIVED
 COMMUNITY DEVELOPMENT DEPARTMENT
 FEB 17 2010
 Print Name LING WONG
 Signature Wing
 Address 625-34th

Reason for opposing or approving this request may be listed below:

- Too much traffic on 34th from people cutting through.
 - NOT IN FAVOR of closing 34th off to traffic.
 - Too close to place a busy place - too close to residential
 - would prefer they build INSTEAD on the corner
of 35th and Ingersoll instead.
- LING WONG

Item 2010 00012 Date 2/19/10

I (am) (am not) in favor of the request.

(Circle One)

Print Name AVRON JACKIE SURBER
Signature [Handwritten Signature]

Address 433 34TH STREET, DSM
50312

Reason for opposing or approving this request may be listed below:

WE OPPOSE THIS REQUEST AND FEEL DAN'S SHOULD STICK TO THEIR ORIGINAL PLAN. THE FOLLOWING REASONS ARE WHY WE OPPOSE; TOO MUCH TRAFFIC IN A RESIDENTIAL NEIGHBORHOOD, TOO MUCH NOISE, AND ODOR FROM PROPOSED REQUEST TOO MUCH LIGHTING, AND FAILURE FROM DAN'S TO COMPLY WITH THIS IN THE PAST.

Item 2010 00012 Date 2-10-10

I (am) (am not) in favor of the request.

(Circle One)

RECEIVED
COMMUNITY DEVELOPMENT
Print Name Steve Kovi
Signature [Handwritten Signature]

FEB 22 2010
Address 3311 Ingersoll

Reason for opposing or approving this request may be listed below:

Item 2010 000124

Date 2/10/10

(am) (am not) in favor of the request.

RECEIVED

COMMUNITY DEVELOPMENT

Print Name

Need Co-op Housing Assoc

FEB 16 2010

Signature

[Signature]

DEPARTMENT

Address

219 4th st

Reason for opposing or approving this request may be listed below:

Item 2010 000124

Date 2-10-10

(am) (am not) in favor of the request.

RECEIVED

COMMUNITY DEVELOPMENT

SALE LAMBERSON

FEB 16 2010

[Signature]

DEPARTMENT

657 36th St

Reason for opposing or approving this request may be listed below:

Item 2010 00012 Date 2/12/10

(am) (am not) in favor of the request.

RECEIVED
(Circle one)
COMMUNITY DEVELOPMENT

Name Loretta A. Cooley

FEB 10 2010 Signature [Signature]

DEPARTMENT

Address 3401 Ingersoll Ave

Reason for opposing or approving this request may be listed below:

Pay of \$100,000.00

Item 2010 00012 Date 2-17-10

(am) (~~am not~~) in favor of the request.

(Circle One)

Print Name BED Bishop

Signature [Signature]

Address 619-36ST 623-36ST

Reason for opposing or approving this request may be listed below:

OWNED ADDRESS LIQED IN THIS AREA FOR

63 YEARS. DINK'S HAS ALWAYS BEEN A

POOD NESTH BOK.

RECEIVED

APR 1 2010

COMMUNITY DEVELOPMENT
DEPARTMENT

Date 4-26-10

Agenda Item 57

Roll Call # _____

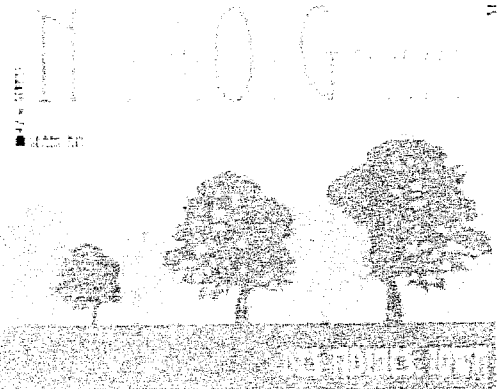

April 1, 2010

To: Members of the Plan and Zoning Commission

From: The North of Grand Neighborhood Association

The North of Grand Neighborhood Association's mission is to ensure that existing and projected infrastructure systems are managed or developed so they enhance the physical, visual and spatial qualities of the neighborhood –promoting a healthy climate for area businesses, and public and private properties.

It is our understanding that you have received several letters indicating support for the proposed amendments to the PUD located at 3401, 3407, and 3425 Ingersoll Ave. The North of Grand Neighborhood Association also firmly supports the success of Dahl's foods and we are in support of the following elements and amendments:

1. The revised angled parking configuration and resulting reduction of parking stalls;
2. The presence of a convenience store and fueling stations;
3. Increasing the number of fueling stations as proposed;
4. The inclusion of the car wash;
5. The construction of a new bank and/or retail/commercial building adhering to NPC guidelines at 34th and Ingersoll.

However, we reluctantly cannot support moving the fueling station and convenience store from 35th street to 34th street for the following reasons:

1. The proximity of a high traffic volume commercial business next to residential properties;
2. Neighbor concerns about the high traffic volume, increased site and building lighting, and increased noise levels near the residential corner of 34th and Ingersoll;
3. Compromised pedestrian safety on and adjacent to the development site.

Principally, as an association, we feel the intersection at 35th and Ingersoll is simply better suited for this use, due to its proximity to an existing traffic controlled and commercial oriented intersection. Therefore, we remain in support of the currently approved PUD and encourage Dahl's Food's, Inc. to retain the originally proposed location of the convenience store and fueling stations and as a Board have unanimously voted to support the location identified on the 2008 plan.

We would like to thank the City of Des Moines and Plan and Zoning Commissioners, Dahl's Foods, and Larry James for meeting with the neighborhood association and including the North of Grand residents in this process. We realize this urban site, with its density and mix of uses, creates constraints and challenges not always present on development sites. With these constraints, if properly navigated, comes the opportunity for a vibrant, healthy, and pedestrian friendly neighborhood. We feel this would be best accomplished by completing the project as originally planned with the convenience store and fueling stations located at the corner of 35th and Ingersoll.

Respectfully,

Kimberly Hansen

President

North of Grand Neighborhood Association

RECEIVED

MAR 05 2010

COMMUNITY DEVELOPMENT
DEPARTMENT

February 27, 2010

P&Z Commission
Dann Flaherty
602 Robert Ray Drive
Des Moines, IA 50309



Dear Mr. Flaherty:

This letter is in response to Dahl's request to rezone the property at 3401 & 3407 Ingersoll Ave. from NPC to PUD. I, as an immediate neighbor and in the zoning request perimeter and a shopper at Dahl's do not support the change in rezoning. The new site plan enters and exits 34th Street, a residential street.

I have lived in my home for 40 years, raised my family and have seen the changes in the area and am in favor of progress for our neighborhood. I support the existing 2008 plan, with a convenience store and 10 fueling stations, at the corner of 35th & Ingersoll, the commercial corridor.

As you well know, all the streets are very narrow, and the traffic will not support any more commercial activity on 34th Street, and still remain safe to the children and residents.

Please consider the residents in our neighborhood, and I'm sure after you visit the proposed area and added changes, you will agree with me that Dahl's has expanded enough, and deny their request.

Thank you for your attention and consideration.

Sincerely,

Patty Rios Iseminger
654-34th Street
Des Moines, IA 50312

SENT CARD ALSO

57

RECEIVED

FEB 24 2010

COMMUNITY DEVELOPMENT
DEPARTMENT

Dear Mr. Dann Flaherty,



This letter is in response to Dahl's request to rezone the property at 3401 & 3407 Ingersoll Ave. From NPC to PUD. We, as immediate neighbors (in zoning request area) & customers of Dahl's, do not support the change in rezoning of 3401 & 3407 Ingersoll Ave. from NPC to PUD. Or the new site plan. With using 34th St. as Dahl's entrance & exit from their property onto 34th St. a residential street.

We support the existing 2008 plan, with a convenience store and 10 fueling stations, at the SW corner of 35th & Ingersoll. The commercial corridor. We are worried about the overall quality of life that will be affected by Dahl's new plan of adding more commercial expansion closer to residential area.

Thank you for taking the time to hear our concerns.

Respectfully yours,
Mike & Trudi O'Connell
637 34th ST.

SENT CARD ALSO

- Susan Houts 3325 Crescent
- Ling Wong 625 34th St.
- Aaron & Jackie Surber 633 34th St.
- Ash & Angie Larson 635 34th St.
- Patty Iseminger 654 34th St.
- Ron & Ann Bonnano 648 33rd St.
- Russ & Steph Anderson 3211 Woodland Ave.
- Jennifer Barsetti 3311 Woodland Ave.
- Patrick Tasler 3315 Woodland Ave.
- Matt & Trina Braffhart 3317 Woodland Ave.

RECEIVED

FEB 24 2010

COMMUNITY DEVELOPMENT DEPARTMENT

Jennifer Barsetti
3311 Woodland Avenue
Des Moines, IA 50312
February 22, 2010

Dan Flaherty
Planning and Zoning Commission
602 Robert Ray Drive
Des Moines, IA 50309



Dear Mr. Flaherty,

This letter is in response to Dahl's request to rezone the property at 3401 & 3407 Ingersoll Avenue from NPC to PUD. We, as immediate neighbors (in the zoning request) and customers of Dahl's do not support the rezoning of 3401 & 3407 Ingersoll Avenue from NPC to PUD, or the new site plan. I am strongly opposed to Dahl's, their customers and their vendors using a residential street (34th Street) as a means to access their property. We support the existing 2008 plan, with a convenience store and 10 fueling stations, at the corner of 35th Street and Ingersoll Avenue, the commercial corridor.

Thank you for your attention to this important matter.

Jennifer Barsetti
Jennifer Barsetti

SENT CARD ALSO

- Susan Houts: 3325 Crescent.
- Ling Wong 625 34th St.
- Aaron & Jackie Surber 633 34th St.
- Ash & Angie Larson 635 34th St.
- Mike & Trudi O'Connell 637 34th St.
- Patty Iseminger 654 34th St.
- Ron & Ann Bonnano 648 33rd St.
- Russ & Steph Anderson 3211 Woodland Ave.
- Patrick Tasler 3315 Woodland Ave
- Matt & Trina Braffhart 3317 Woodland Ave.

RECEIVED

MAR 29 2010

**COMMUNITY DEVELOPMENT
DEPARTMENT**

Linden Heights Neighborhood Association
4245 Foster Drive
Des Moines, Iowa 50312

March 29, 2010

Plan and Zoning Commission
City of Des Moines
602 Robert D. Ray Drive
Des Moines, Iowa 50309

Dear Board Members,

The City Community Development Department has notified the Linden Heights Neighborhood Association that Dahl's has filed a PUD amendment to allow for the further development of their site at 3401, 3407, and 3425 Ingersoll to include a convenience store, gas pumps, car wash, and branch bank. Our Association has received copies of the site plan, conceptual drawings, city staff recommendations, and traffic studies. The Plan and Zoning Commission will act on the zoning change at its monthly meeting on April 1, 2010, in the City Council chambers.

The LHNA board voted unanimously to support the proposed development. The site plan for the planned unit development district is in harmony with the existing properties along Ingersoll. We believe this development will be a magnet for other developments on Ingersoll. The results of the traffic studies indicate that the development plan will not have an adverse impact on the intersection traffic flow. Ingersoll is the primary commercial corridor for the west side of Des Moines, and the proposed improvements will benefit the entire area.

The Linden Heights Neighborhood Association ("LHNA") was recognized by the City of Des Moines on December 7, 1998. One of the first projects undertaken by our Association was the successful application to list the neighborhood as an historic district on the National Register of Historic Places. LHNA is an active neighborhood association, and 76% of our households are dues paying members.

Respectfully Yours,

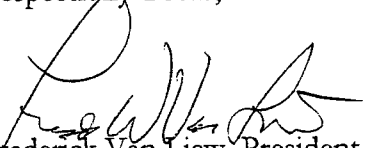
Frederick Van Liew, President
Board of Directors
Linden Heights Neighborhood Association

Cc
Jason Van Essen, City Planner
Larry James, Jr.
LHNA Board of Directors



RECEIVED

MAR 26 2010

COMMUNITY DEVELOPMENT DEPARTMENT

1922 Ingersoll Avenue • Des Moines, Iowa 50309 • info@ingersollave.com • ingersollave.com

Ingersoll Business Association
1922 Ingersoll Avenue
Des Moines, IA 50309

March 24, 2010

City of Des Moines
Attn: Jason Van Essen
Plan and Zoning Commission
400 Robert D. Ray Drive
Des Moines, IA 50309

Mr. Van Essen,

It has come to our attention that Dahl's Grocery has proposed a plan that will change the landscape of their property on Ingersoll Avenue and 35th Street. This letter is to inform the Plan and Zoning Commission, that the Ingersoll Business Association Board of Directors fully supports the Dahl's project.

We feel the proposed plan is in the best interest of the Ingersoll community and will only add value to this area of the city. We are thrilled to see the incorporation of the Restoration Ingersoll landscape plan into the proposal and feel this will generate additional interest in the continuation of the restoration project.

Our mission is to enhance culture and commerce on Ingersoll Avenue, support our members and make Ingersoll a great place to live, shop and do business. It is important for our board to state our approval of this project since the proposal works in favor of our goals as an organization. We hope you will consider the voice of our members as you make decisions surrounding this project.

Please feel free to contact me if you have any questions or comments.

Sincerely,
Stephanie Jewell
Stephanie Jewell

President
Ingersoll Business Association

RECEIVED

MAR 24 2010

COMMUNITY DEVELOPMENT
DEPARTMENT

March 23, 2009

Larry Hulse
Planning and Zoning Commission
City of Des Moines

Larry;

The Restoration Ingersoll Committee has met with a representative from the Dahls' store who presented the planned additions to the property to us. We studied the plans and had a great opportunity to make suggestions and to comment on certain parts of the plan. Dahls took our comments into consideration and made a few of the changes that we suggested.

We believe that Dahls is a valuable member of our Ingersoll business community and we would like to publically offer our full support of their plan. They have been very supportive of our efforts and we fully expect them to follow the Restoration Ingersoll plan as they complete this next phase of their work.

We would appreciate it if you could pass this letter on to the rest of the Planning and Zoning Committee.

Thank you so much for your efforts to keep our city in good shape.

Restoration Ingersoll Committee

Co-Chairs

Soozie McBroom

Kim Hansen (abstained from vote)

Ted Irvine (abstained from vote)

Mike Hutchison

Janis Ruan

Kaye Lozier

Mark Holub

Michael Woody





RECEIVED

MAR 29 2010

COMMUNITY DEVELOPMENT DEPARTMENT

March 29, 2010

City Plan & Zoning Commission
Attn: Chair Dan Flaherty
City of Des Moines
602 Robert D. Ray Drive
Des Moines, Iowa 50309

Re: Westside Des Moines Chamber of Commerce
Letter in Support of Dahls Foods Ingersoll Avenue, PUD Conceptual Plan

Dear Chair Flaherty:

As president of the Des Moines Westside Chamber, our Board writes to you and all Plan & Zoning Commissioners in support of the Dahls Food Ingersoll Avenue PUD Conceptual Plan to include 6 fuel pumps, an automatic carwash, bank building, and convenience store, set for your consideration at your meeting April 1, 2010. Dahls Food Store has been an integral part of Des Moines west side business and has served as our local neighborhood grocery store for generations of Des Moines citizens. Their newly constructed grocery store is a tremendous asset to the city generally and west side specifically. Their current proposal would complete site development and be a tremendous addition to the Ingersoll business community. We urge you to approve proposed Conceptual Plan as originally outlined and amended.

Sincerely,

Steve Purcell
President, Des Moines Westside Chamber

cc: Dahls Food Store
Attn: Store Manager
3425 Ingersoll Avenue
Des Moines, Iowa 50312

cc: email: jmvanessen@dmgov.org

57

LAW OFFICES OF
**HOPKINS
& HUEBNER, P.C.**

RECEIVED

MAR 31 2010

COMMUNITY DEVELOPMENT
DEPARTMENT

Des Moines Office
2700 Grand Avenue, Suite 111
Des Moines, Iowa 50312-5213
Phone: 515-244-0111
Fax: 515-244-8935

March 31, 2010

SENT VIA FAX - 283-4270

City Plan & Zoning Commission
City of Des Moines
602 Robert D. Ray Dr.
Des Moines, IA 50309

RE: Dahls Foods Ingersoll Avenue, PUD Conceptual Plan

To Whom It May Concern:

I am writing to indicate to you my support for the Dahls Food Ingersoll Avenue PUD Conceptual Plan. I understand this plan is going to be considered by your commission on April 1, 2010.

The new Dahls store is a terrific facility and a welcome addition to the Ingersoll area. The addition of the proposed bank building and convenience store would round out the development of this site and would be a welcome addition to the area. I would encourage you to approve the conceptual plan.

Sincerely,

HOPKINS & HUEBNER, P.C.

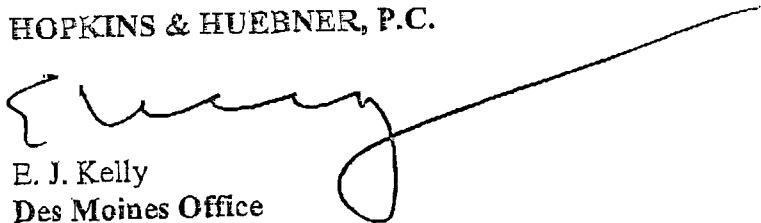
E. J. Kelly
Des Moines Office

Direct dial: 515-697-4250
Direct fax: 515-697-4299
Email: ejkelly@hopkinsandhuebner.com

cc: Dahls Food Store
Attn: Store Manager
3423 Ingersoll Ave.
Des Moines, IA 50312

S:\JVL\Com\P&A Commissioner 100331.doc4370

- E. J. Giovannetti
- Jeff H. Jeffries
- R. Ronald Pogge
- Dennis L. Hunsson
- Lorraine J. May
- William L. Dawe
- E. J. Kelly+
- Gregory T. Rucette #
- Valerie A. Landis
- Jeff M. Margolin *
- Anne L. Clark
- Matthew A. Grotnes
- Jane V. Lorentzen
- Hugh J. Cain
- Tina M. Eick
- Barbara A. Hering
- Brian Q. Pals
- April M. DeLange
- Thomas P. Murphy
- B. J. Terrance
- Wendy D. Bokuo
- Nicholas W. Platt
- Michelle R. Rodemyer
- Brian T. Israel

Robert C. Lundess (Of Counsel)

- Terrance A. Hopkins (Retired)
- Frank T. Harrison (Retired)
- Thomas J. Logan (Retired)
- Fred D. Huebner (1919-1996)
- Murvin F. Duckworth (1942-2003)
- Philip H. Dorff (1949-2009)

Quad Cities Office
Northwest Bank Tower
100 E. Kimberly Road, Suite 704
Davenport, Iowa 52806-5944
Phone: 563-445-2264
Fax: 563-445-2267

- M. Anne McAtee *
- Michael C. Walker *
- Paul Salubert, Jr. *
- Patrick T. Vint *
- Maggie R. Mantemuch *

Adel Office
1009 Main Street
P. O. Box 99
Adel, Iowa 50003-1454
Phone: 515-993-4545
Fax: 515-993-5214

James E. Van Worden
Adam Dull

- * Also admitted in Illinois
- + Also admitted in Nebraska
- # Also admitted in Michigan
- o Also admitted in Arizona

Whitfield, Cathy L.

*From: Tom McKlveen [mcklbr@prairieinet.net]
Sent: Wednesday, March 31, 2010 11:50 AM
To: Whitfield, Cathy L.
Subject: Planning and Zoning mtg., April 1, 2010*

I am writing to express my concern and object to Item #1 on the P & Z agenda for April 1. The item concerns Foods, Inc. request for a rezoning to allow fuel pumps, convenience store, and car wash on Ingersoll Ave.

That type of development right along Ingersoll is NOT in keeping with the existing character of the street or the neighborhood. That type of development is NOT pedestrian friendly. There have been some nice upgrades to the streetscape on Ingersoll, and this would run counter to those improvements. Finally, I don't understand why Dahl's is asking for a re-zoning when they just recently built a new facility at that location.

Please, please, please protect the integrity of this street and this neighborhood.

Thank you.

Tom McKlveen
5803 N. Waterbury Road
Des Moines, IA 50312
cell: 515-202-6171

ps: I would attend your meeting in person if I had not planned to be out of town tomorrow.

RECEIVED
MAR 31 2010
COMMUNITY DEVELOPMENT
DEPARTMENT